



# 小型交流齿轮减速电机

SMALL AC GEAR MOTOR

中大力德 实现自动化应用的无限可能

# 电机驱动 微特电机 精密减速器



▲ 总公司 宁波中大力德智能传动股份有限公司



▲ 子公司 宁波中大创远精密设备有限公司



▲ 子公司 佛山中大力德驱动科技有限公司

宁波中大力德智能传动股份有限公司始创于1998年，是一家集电机驱动、微特电机、精密减速器、机器人结构本体及一体化智能执行单元的研发、制造、销售、服务于一体的国家高新技术企业。公司注册资本15117万元，分、子公司9家，员工1800余人，2017年8月在深交所主板上市，股票代码：002896。

公司系国家级高新技术企业，主导和参与起草国家标准12项，行业标准5项；授权专利107项，其中发明专利14项。拥有机械工业精密齿轮减速电机工程研究中心、浙江省级高新技术企业研究开发中心、浙江省级企业技术中心。

公司立足于智能化、自动化装备核心零部件设计和制造，为客户提供智能驱动解决方案。公司产品以其差异化和高性价比优势，广泛应用于工作母机、数控设备、工业机器人、智能物流、新能源、食品、包装、纺织、电子、医疗、通讯、农牧等机械装备领域。在替代进口产品的基础上，逐步参与国际竞争。

Ningbo Zhongda Leader Intelligent Transmission Co., Ltd. was founded in 1998. It is an electromechanical automation enterprise integrating R&D, manufacturing, sales and service of motor drives, micro motors, precision reducers and integrated products. It has 9 branches and subsidiaries, over 1,800 employees, and a registered capital of 151.17 million yuan. In August 2017, it was listed on the A-shares of the Shenzhen Stock Exchange (stock code 002896).

The company is a national-level high-tech enterprise, leading and participating in the drafting of 10 national standards and 5 industry standards, maintaining 107 patents and 11 invention patents. It's owning a Zhejiang-level enterprise R&D center.

The company is based on intelligent and automation equipment core component manufacturers and design solution providers. With its differentiated and cost-effective advantages, the company's products are widely used in industrial robots, intelligent logistics, new energy, machine tools and other fields, as well as special machinery and equipment for food, packaging, textiles, electronics, and medical treatment. On the basis of realizing domestic substitution of imported products, gradually participate in international competition.

# 小型交流减速电机机型简介

## MEAN OF INDICATORS

### ■ 小型标准型 Small Standard

机型/规格 Model/Specification		
功率/速比 Power/Speed Ratio		
型号 Model	速比 Speed Ratio	箱号-轴径-键 Box Number Axis Diameter Key
100W 1/8HP	3-50	1-18-5
	60-100	2-22-7
	110-200	2-22-7
	250-1800	3-28-7
200W 1/4HP	3-10	1-18-5
	15-30	2-22-7
	35-90	2-22-7
	100-200	3-28-7
400W 1/2HP	250-1800	4-32-10
	3-10	2-22-7
	15-35	3-28-7
	40-90	3-28-7
750W 1HP	100-200	4-32-10
	250-1800	5-40-10
	3-10	3-28-7
	15-25	3-28-7
1500W 2HP	30-60	4-32-10
	70-120	4-32-10
	125-200	5-40-10
	250-1800	6-50-14
	3-10	4-32-10
2200W 3HP	15-30	4-32-10
	40-60	5-40-10
	70-100	5-40-10
	110-200	6-50-14
	3-10	5-40-10
3700W 5HP	15-40	5-40-10
	45-100	6-50-14
	3-10	5-40-10
	15-25	6-50-14
3700W 5HP	30-60	6-50-14
	75-100	6-50-14
	3-10	5-40-10

### ■ 小型缩框型 Small Scaled Frame Type

机型/规格 Model/Specification		
功率/速比 Power/Speed Ratio		
型号 Model	速比 Speed Ratio	箱号-轴径-键 Box Number Axis Diameter Key
100W 1/8HP	60-200	1-18-5
	250-1800	2-22-7
200W 1/4HP	15-30	1-18-5
	40-90	1-18-5
	100-200	2-22-7
400W 1/2HP	250-1800	3-28-7
	15-30	2-22-7
	35-90	2-22-7
750W 1HP	100-200	3-28-7
	250-1800	4-32-10
	3-10	2-22-7
	15-25	2-22-7
1500W 2HP	30-60	3-28-7
	70-120	3-28-7
	125-200	4-32-10
	250-1800	5-40-10
	3-10	3-28-7
2200W 3HP	15-30	3-28-7
	40-60	4-32-10
	70-100	4-32-10
	110-200	5-40-10
3700W 5HP	3-30	4-32-10
	45-100	5-40-10
	15-30	5-40-10
3700W 5HP	35-40	5-40-10
	45-100	5-40-10

# 小型交流减速电机型号说明方法 TYPE AND MOTOR MODEL

## ■ 减速电机型号说明 Description Of Motor Model

ZHN - 100 - 50 - SZ - B - G1 - LD - Q1  
 ①            ②            ③            ④            ⑤            ⑥            ⑦            ⑧

①	箱体结构基本代号 Basic structure; ZHN (卧式 Horizontal), ZVN (立式 Vertical)
②	输出功率 Output: 100W, 200W, 400W, 750W, 1100W, 1500W, 2200W, 3000W, 3700W
③	齿轮箱的减速比 Gear ratio: 3, 5, 10...1800
④	电机的基本结构 Motor basic data: S: 三相电机 3-Phase motor, 220-240/380-415V, 50/60Hz C: 单相电机 1-Phase motor, 220V, 50/60Hz E: 单相电机 1-Phase motor, 110V, 50/60Hz DV: 单相双电压电机 Double voltage motor, 110V/220V, 50/60Hz Z: 缩框型减速电机 Light type duty (标准型省略 Standard type omit)
⑤	刹车器 Brake unit B: DC断电刹车器 Brake unit (另配交变直快速整流器 With quick rectifier from AC to DC) YB: 手持放刹车器 Manual brake unit F1: 110V轴流风机, F2: 220V轴流风机, F3: 380V轴流风机, F1: 110V axial fan, F2: 220V axial fan, F3: 380V axial fan
⑥	出轴端看接线盒方位 (如图示) Terminal box direction from output shaft (As shown) G1: 左方向 Left    G2: 右方向 Right    G3: 上方向 Top    G4: 下方向 Down

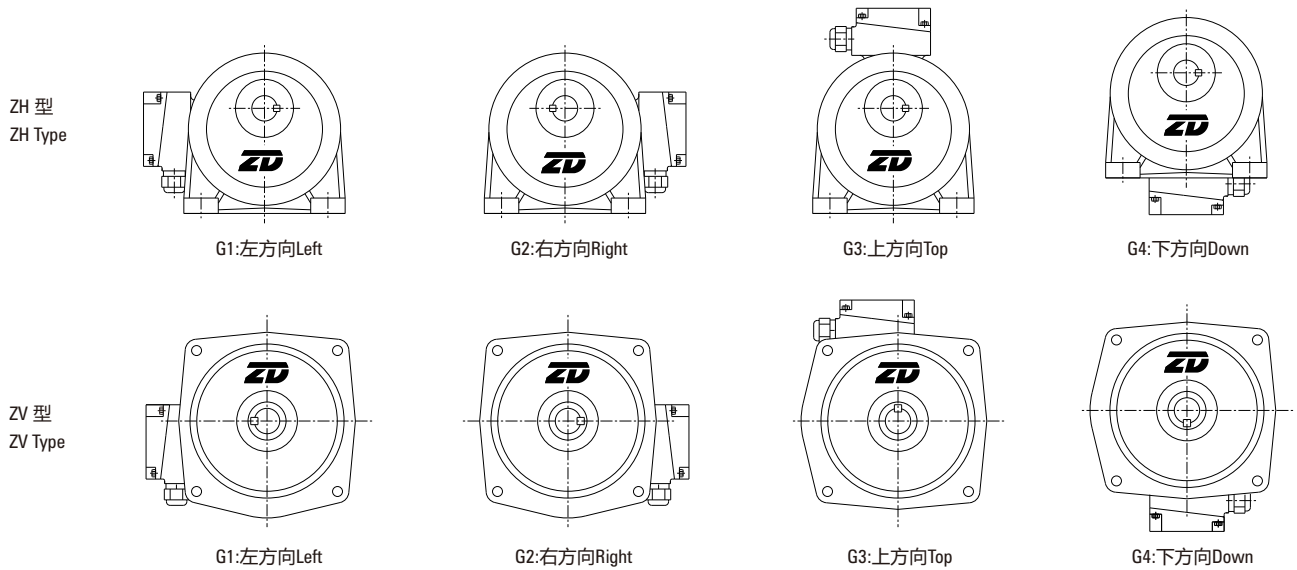

⑦	出轴端看引出线方位 (如图示) Lead direction from output shaft (As shown) T: 向上 Top    D: 向下 Down    F: 向前 Forward    B: 向后 Back    L: 向左 Left    R: 向右 Right
---	--

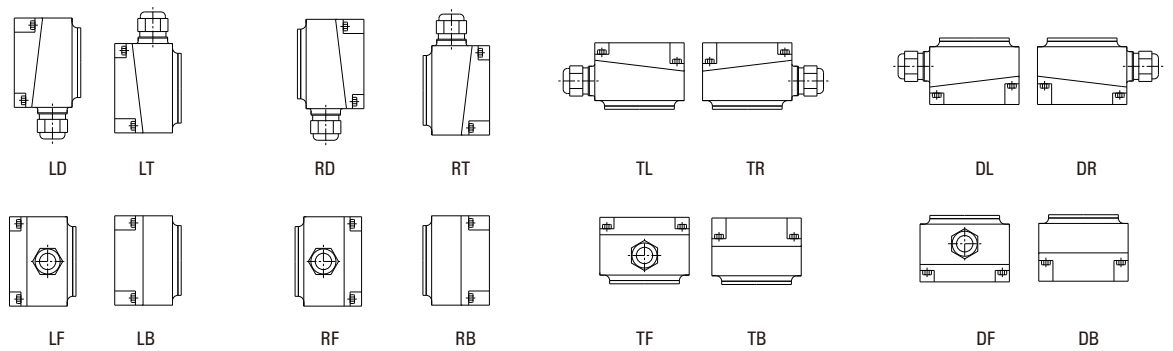

# 小型交流减速电机型号说明方法 TYPE AND MOTOR MODEL

⑧ 出厂标准安装形式：Standard installation method  
 本公司出厂所有减速器适用如图安装形式  
 All of our company's reducer can be applied to the following kinds of installation method  
 图中Q1、Q4中注油孔方向为标准型  
 In the diagram, Q1, Q4, are our standard types of oil hole direction  
 注油孔在特殊位置的，请特别告知，本公司将修改出气孔位置  
 Pls inform us if the location of oil hole is special, we will modify it  
 实际使用时，建议将注油孔中的堵油销拔出，以平衡减速箱内的压力  
 Pls pull out the pin of the oil plug to reduce the pressure in the gearbox during running

Q1 出气孔方向  
Air hold direction

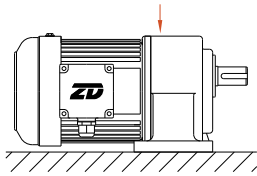

Q2 出气孔方向  
Air hold direction

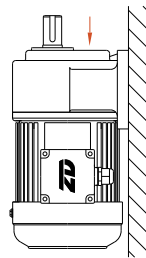

Q3 出气孔方向  
Air hold direction

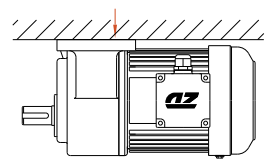

Q4 无出气孔  
No oil filling hole

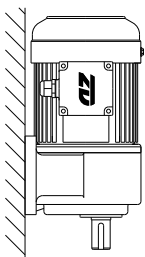

Q5 出气孔方向  
Air hold direction

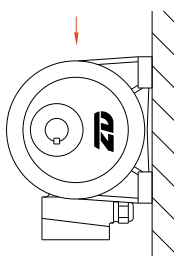

Q6 出气孔方向  
Air hold direction

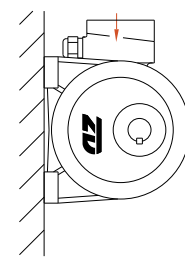

Q1 出气孔方向  
Air hold direction

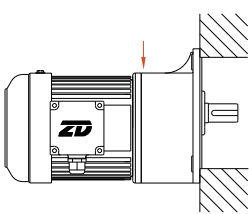

Q2 出气孔方向  
Air hold direction

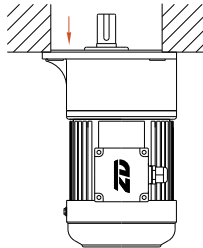

Q3 出气孔方向  
Air hold direction

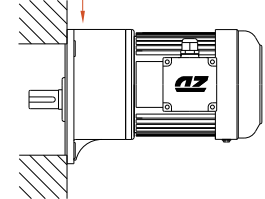

Q4 无出气孔  
No oil filling hole

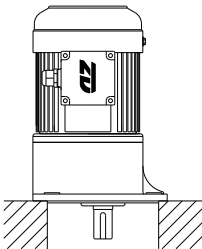

Q5 出气孔方向  
Air hold direction

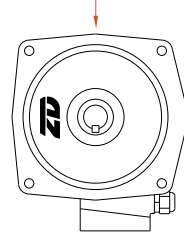

Q6 出气孔方向  
Air hold direction

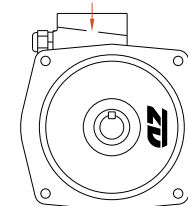

备注 Note:

订购变频电机时，请说明变频范围，减速电机的使用环境工作方式等。

For motors supplied by transducer please tell us detailed working modes and working ambient.

带刹车减速电机总长度需增加10mm。The total length of brake motors will be 10mm longer than standard motors.

# 技术资料 TECHNICAL DATA

## 电机基本规范 Motor Specification

项目 Item	三相电机 3-Phase Motor	单相电机 1-Phase Motor
防护等级 Protection	铝合金壳接线盒为IP54, 铁壳接线盒为IP20 IP54 with alum alloy terminal box, and other is IP20	
外壳材质 Frame material	100W~3700W机壳为铝合金, 1#, 2#, 3#, 4#齿轮箱为铝合金, 5#, 6#齿轮箱为铸铁 Alum alloy for 100W~2200W frame, alum alloy for 1#, 2#, 3#, 4# gear case, 5#, 6# cast iron for others	
工作方式 Duty	连续运转 / Continuous running S1工作制 Duty: S1	
绝缘等级 INS.class	B级(F级)可选/Optional 常规B级 ( F级可选 ) Regular class B (Class F can choose)	
适用环境 Environment	温度 / Temp:-10°C~+40°C 湿度 / Humidity: ≤90%	
使用电压 Voltage	220-240/380-415V, 50/60Hz	110V/50/60Hz, 220V/50/60Hz
极数 Pole	4P (6P)	4P
海拔 Height	≤1000m	
起动方式 Starting	全压起动 Direct start	0.1-0.2Kw单电容起动 Capacitor 0.4-1.5Kw双电容起动 Double capacitors
依据标准 Standard	GB755/IEC-60034	

## 单相电机配套电容值, 电容运转形式 Capacitor For 1-phase Motor, C-running Type

输出功率 Output Power	运转电容 Running Capacitor	起动电容 Starting Capacitor	运转电容+起动电容 (离心开关) Running+Starting Capacitor (Ceutrifugal Switch)
100W, 1/8HP	8μF/450V	/	/
200W, 1/4HP	12μF/450V	/	/
400W, 1/2HP	/	/	15μF/450V+75μF/250V
750W, 1HP	/	/	20μF/450V+150μF/250V
1500W, 2HP	/	/	40μF/450V+200μF/250V

## 刹车性能说明 Function For Brake Unit

输出功率 Output Power	允许最高转速 Permit Max Rpm	刹车制动力 Torque (kg.m)	刹车间隙 Clearance (mm)	重量 Weight (kg)
1/8HP4P-1/4HP4P (100W-200W)	4000	0.15-0.4	0.25-0.5	2.0
1/2HP4P-1HP4P (400W-750W)	3600	0.25-0.7	0.25-0.5	4.3
1.5HP4P-2HP4P (1100W-1500W)	3600	0.92-2.0	0.25-0.5	6.3
3HP4P-5HP4P (2200W-3700W)	3600	1.80-3.5	0.25-0.5	7.0

# 接线方式 WIRING DIAGRAM

## 三相电机接线方式 FOR 3-PHASE MOTOR

### 三相电机接线方式 FOR 3-PHASE MOTOR



Δ接法/220V-240V

Y接法/380V-415V

### 三相电机与刹车器接线方式 THE CONNECTION MODE FOR THREE PHASE MOTOR AND BRAKE

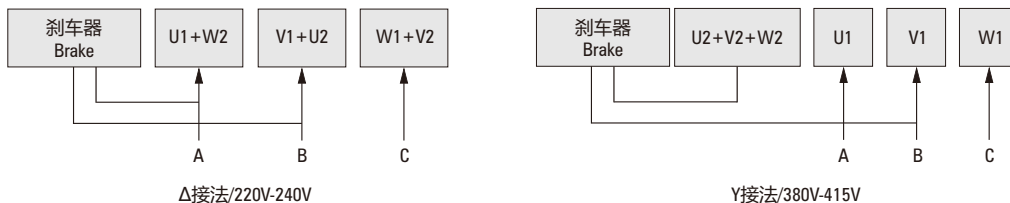

Δ接法/220V-240V

Y接法/380V-415V

※注: 刹车器两根电源线接任意两根接线端。  
Note: Brake wires can connect to either pin.

※注: 刹车器电源线一根接电机公共端, 另外一根接电机任意一组。  
Note: One of brake wire connect to motor public and the other wire connects to either motor wire.

## 单相电机接线方式 FOR 1-PHASE MOTOR C表示电容 C FOR CAPACITOR

### 单相电机接线方式 FOR 1-PHASE MOTOR

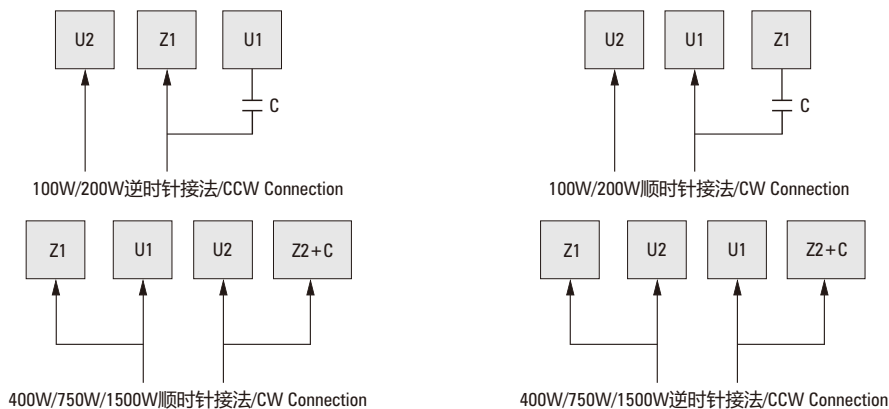

100W/200W逆时针接法/CCW Connection

100W/200W顺时针接法/CW Connection

400W/750W/1500W顺时针接法/CW Connection

400W/750W/1500W逆时针接法/CCW Connection

### 单相电机与刹车器接线方式 THE CONNECTION MODE FOR SINGLE PHASE MOTOR AND BRAKE

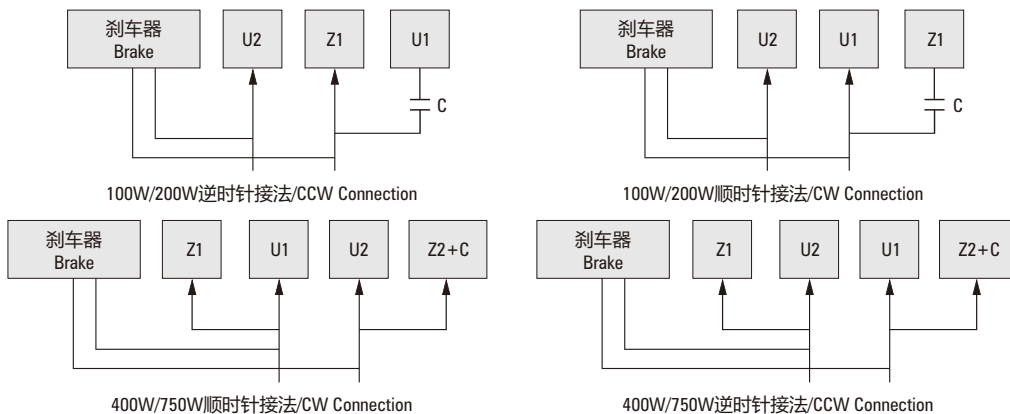

100W/200W逆时针接法/CCW Connection

100W/200W顺时针接法/CW Connection

400W/750W顺时针接法/CW Connection

400W/750W逆时针接法/CCW Connection

※备注: 电机变频时, 刹车器请单独接电源。电机使用频率低于30Hz时, 必须带轴流风机, 轴流风机须单独接电源。  
※Note: Please connect brake wire to power single when motor frequency converts. Motor must match a separate fan when run under 30Hz.

■ 输出轴允许最大轴径 Available Max Output Shaft Diameter

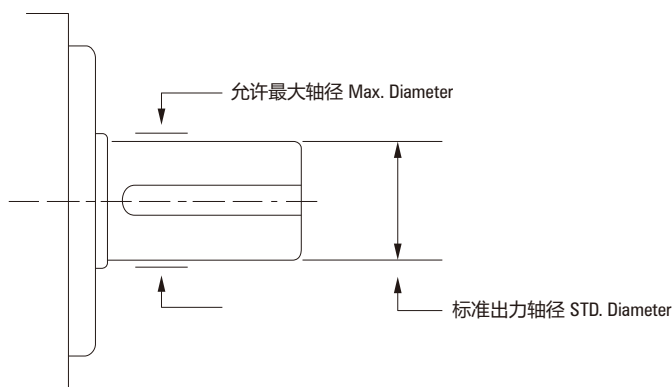

齿轮箱型号 Gear Box	标准出轴直径 Atanddre Output Shaft Dia	最大允许直径 Max Availablet Shaft Dia	输出端轴承 Output Fed Bearing
1#	Φ18	Φ20	6004
2#	Φ22	Φ25	6205
3#	Φ28	Φ30	6206
4#	Φ32	Φ35	6207
5#	Φ40	Φ45	6209
6#	Φ50	Φ55	6211

■ 减速电机各零件部分大致说明 Main Parts Notes

部件名称 Parts Name	说明 Notes
箱体 Gearbox	1#、2#、3#、4#箱体出轴直径为18、22、28、32，箱体采用铝合金，5#、6#箱体出轴直径为40、50，箱体采用铸铁。 The output shaft diameter of gearbox 1#、2#、3#、4# are 18、22、28、32 separately. The material of gearbox is Al. alloy. 5#、6# are 40、50 respectively. Gearbox is made of cast iron.
齿轮片 Gear piece	齿轮材料为40Cr，调质HB280，高精度滚齿，齿部高频淬火HRC50，齿面磨齿，齿轮精度6级。 The material 40Cr mixes to HB280, then dealt with high frequency quencher HRC50. Gear should be processed by milling with high precision. The class is 6.
齿轮轴 Gear shaft	齿轮材料为20CrMnTi，高精度滚齿，渗碳淬火HRC60，齿面二次刮削，精度6级。 The material 20CrMnTi will be changed into HRC60 through processing of cementite quencher. Gear shaft will be processed with gear hobbing. Precision class is 6.
电机轴 Motor shaft	齿轮材料为20CrMnTi，高精度滚齿，渗碳淬火HRC60，齿面二次刮削，精度6级。 The material 20CrMnTi will be changed into HRC60 through processing of cementite quencher. Gear shaft will be processed with gear hobbing. Precision class is 6.
轴承 Ball bearing	电机部分轴承采用高精度等级精密轴承，以确保长期运转寿命。 We adopt tight bearing with high precision, to make sure longterm running life.
油封 Oil seal	电机轴以耐高温油封为主，可有效防止油脂渗漏。 Gear shaft gives priority to enduring high temp, avoiding oil infiltration.
接线盒 Terminal box	有两种：一种是铝合金接线盒，有较好的防水及防尘性能，防护等级为IP54。 另外一种是铁壳的接线盒，结构轻巧，防护等级IP20。 Two type. One is Al alloy, which equipes good capability of waterproof and dustproof. Protection grade is Ip54. The other is steel case with deft structure. Protection grade is IP20.



产品结构图  
DETAILS PARTS LIST

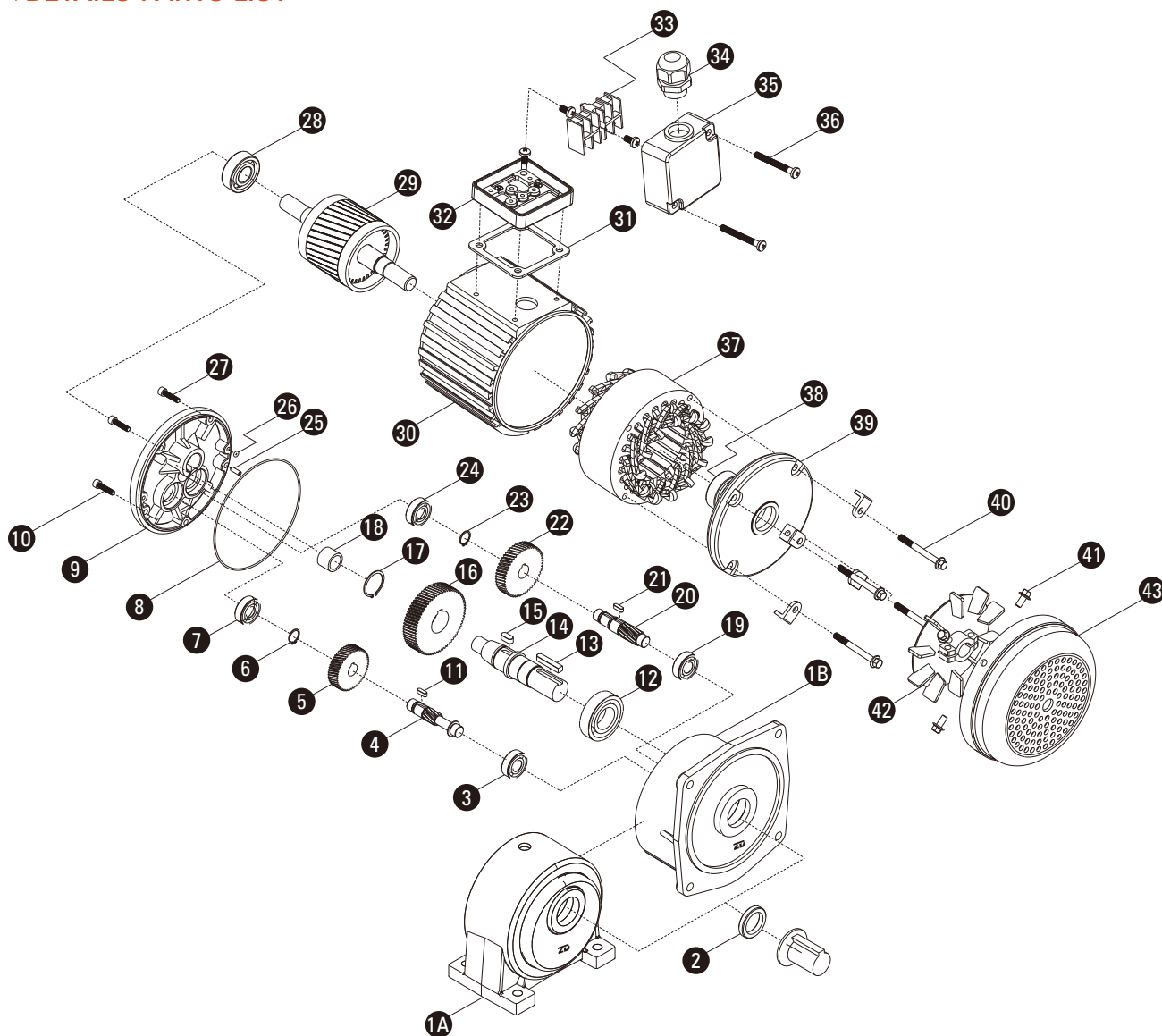

■ 明细表 Parts List

序号 Item	名称 Name	序号 Item	名称 Name	序号 Item	名称 Name
1A	卧式 Horizontal housing	15	三级小齿轴键 Key-3RD pinion	30	机壳 Shell
1B	立式 Vertical housing	16	三级大齿轮 Gear-3RD stage	31	密封垫 A seal
2	输出轴油封 Oil seal-output shaft	17	C-挡圈 Snap ring	32	接线盒底座 Junction box base
3	二级齿轴承 Bearing-2ND stage pinion	18	输出轴自润轴承 Oilless bearing	33	接线端子 Terminal block
4	二级小齿轴 Pinion-3ND stage	19	二级齿轴承 Bearing-2ND stage pinion	34	锁紧器 Locking device
5	一级大齿轮 Gear-1ST stage	20	三级小齿轴 Pinion-2ND stage	35	接线盒盖 Junction box
6	C-挡圈 Snap ring	21	三级小齿轴键 Key-3RD stage pinion	36	固定螺钉 Fixed screw
7	二级齿轴承 Bearing-2ND stage pinion	22	二级大齿轮 Gear-2RD stage	37	定子总成 Stator
8	O型圈 Oil ring	23	C-挡圈 Snap ring	38	电机轴承 Bearing of shaft
9	电机前盖 Front cover	24	三级齿轴承 Bearing-3ND stage pinion	39	后端盖 Back cover
10	内六角螺钉 Hex-head screw	25	定位销 Pin	40	固定螺栓 Fixed bolt
11	二级小齿轴键 Key-2RD stage pinion	26	O型圈 Oil ring	41	内六角螺钉 Hex-head screw
12	输出轴承 Bearing-output shaft	27	内六角螺钉 Hex-head screw	42	风叶 Fan
13	输出轴键 Key-output shaft	28	电机轴承 Bearing of shaft	43	风罩 Fan cover
14	输出轴 Output shaft	29	转子 Rotor		

# 1#齿轮箱出轴直径Φ18mm配三相电机技术参数 1#GEARBOX WITH SHAFT DIA Φ18mm WITH 3-PHASE MOTOR PARAMETERS

## 卧式 Horizontal

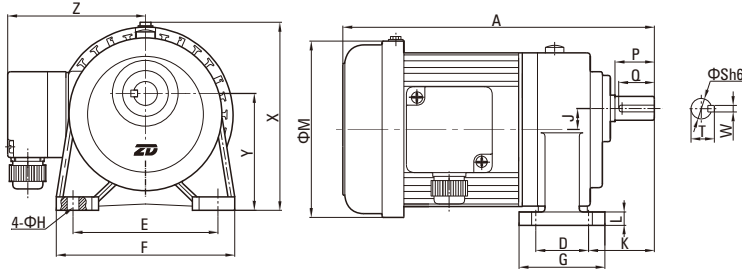

## 立式 Vertical

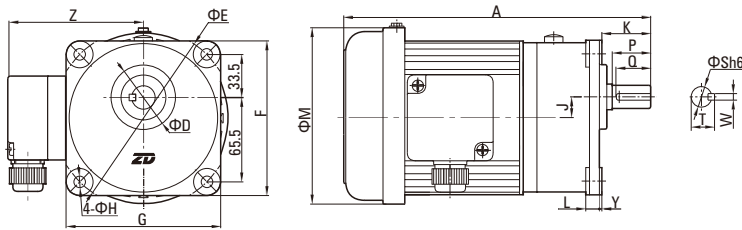

## 尺寸表 Size Table

单位 Unit:mm

功率 Power	减速比Ratio	A	D	E	F	G	H	J	K	L	M	X	Y	Z	S	P	Q	W	T	重量Weight
100W 1/8HP	标准型3-50	254	40(50)	110(140)	135(120)	65(120)	9	16	50(39.5)	10(12)	130.5	143(/)	88.5(2)	100	18	30	27	5	20.2	5.7
	缩框型60-200	254	40(50)	110(140)	135(120)	65(120)	9	16	50(39.5)	10(12)	130.5	143(/)	88.5(2)	100	18	30	27	5	20.2	5.7
200W 1/4HP	标准型3-10	279	40(50)	110(140)	135(120)	65(120)	9	16	50(39.5)	10(12)	130.5	143(/)	88.5(2)	100	18	30	27	5	20.2	7.0
	缩框型15-90	279	40(50)	110(140)	135(120)	65(120)	9	16	50(39.5)	10(12)	130.5	143(/)	88.5(2)	100	18	30	27	5	20.2	7.0

※表中“( )”内为立式箱体尺寸。

※Labulation“( )”denote vertical box dimension.

## 输出轴容许扭矩 Output Torque

单位 Unit:kg.m

功率 Power	类型 Type	速 频 率	3	5	10	15	20	25	30	40	45	50	60	70	80	90	100	120	140	160	180	200	
100W 1/8HP	标准型 Standard type	50Hz	0.20	0.30	0.60	0.80	1.10	1.40	1.70	2.30	2.50	2.80	/	/	/	/	/	/	/	/	/	/	/
		60Hz	0.10	0.20	0.50	0.70	0.90	1.20	1.40	1.90	2.10	2.30	/	/	/	/	/	/	/	/	/	/	/
	缩框型 Light duty type	50Hz	/	/	/	/	/	/	/	/	/	/	3.40	3.40	3.40	3.40	3.40	3.40	3.40	3.40	3.40	3.40	3.40
		60Hz	/	/	/	/	/	/	/	/	/	/	3.40	3.40	3.40	3.40	3.40	3.40	3.40	3.40	3.40	3.40	3.40
200W 1/4HP	标准型 Standard type	50Hz	0.30	0.60	1.10	/	/	/	/	/	/	/	/	/	/	/	/	/	/	/	/	/	/
		60Hz	0.30	0.50	0.90	/	/	/	/	/	/	/	/	/	/	/	/	/	/	/	/	/	/
	缩框型 Light duty type	50Hz	/	/	/	1.70	2.30	2.80	3.40	3.40	3.40	3.40	3.40	3.40	3.40	3.40	/	/	/	/	/	/	/
		60Hz	/	/	/	1.40	1.90	2.30	3.40	3.40	3.40	3.40	3.40	3.40	3.40	3.40	/	/	/	/	/	/	/

2#齿轮箱出轴直径  $\Phi 22\text{mm}$  配三相电机技术参数  
 2# GEARBOX WITH SHAFT DIA  $\Phi 22\text{mm}$  WITH 3-PHASE MOTOR PARAMETERS

■ 卧式 Horizontal      ■ 立式 Vertical



■ 卧式 Horizontal

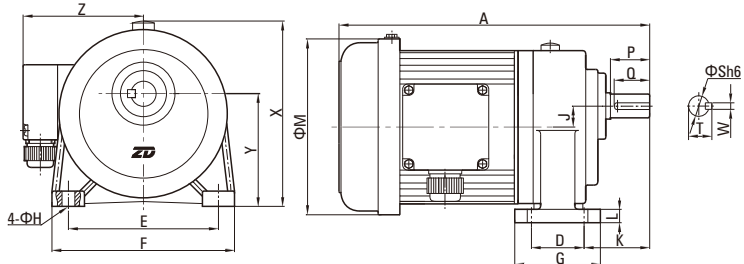

■ 立式 Vertical

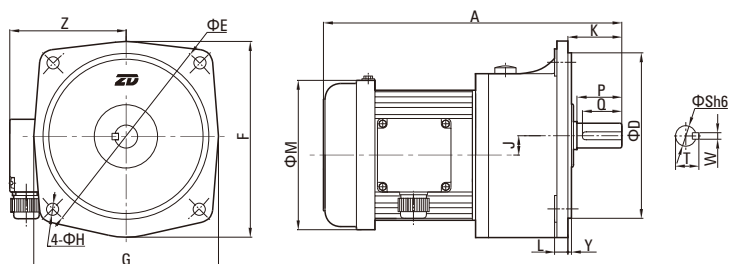

■ 高速比(1#+2#) High Ratio(1#+2#)



■ 卧式 Horizontal

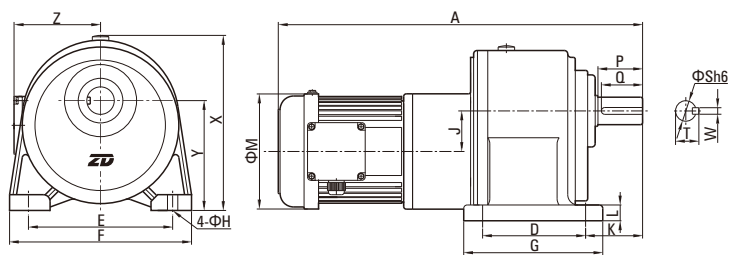

■ 立式 Vertical

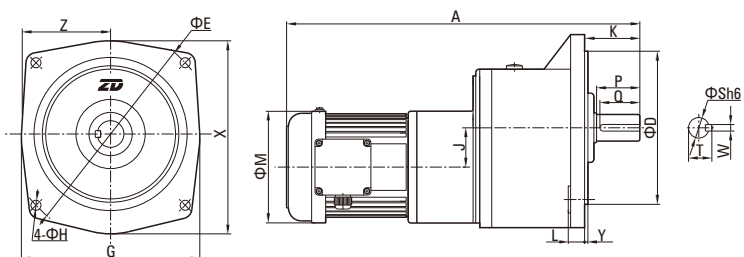

## 2#齿轮箱出轴直径Φ22mm配三相电机技术参数 2#GEARBOX WITH SHAFT DIA Φ22mm WITH 3-PHASE MOTOR PARAMETERS

尺寸表 Size Table

单位 Unit:mm

功率 Power	减速比 Ratio	A	D	E	F	G	H	J	K	L	M	X	Y	Z	S	P	Q	W	T	重量 Weight
100W 1/8HP	标准型 60-200	281	65(148)	130(185)	158(175)	90(165)	12	17.5	60(48)	13(12)	130.5	161(/)	97.5(3)	100	22	40	35	7	25	7.30
	缩框型 250-180 (1# + 2#)	341	65(148)	130(185)	158(175)	90(165)	12	33.5	60(48)	13(12)	130.5	161(/)	97.5(3)	100	22	40	35	7	25	12.0
200W 1/4HP	标准型 15-90	306	65(148)	130(185)	158(175)	90(165)	12	17.5	60(48)	13(12)	130.5	161(/)	97.5(3)	100	22	40	35	7	25	9.00
	缩框型 100-200	306	65(148)	130(185)	158(175)	90(165)	12	17.5	60(48)	13(12)	130.5	161(/)	97.5(3)	100	22	40	35	7	25	9.00
400W 1/2HP	标准型 3-10	320	65(148)	130(185)	158(175)	90(165)	12	17.5	60(48)	13(12)	146	168(/)	97.5(3)	114	22	40	35	7	25	11.5
	缩框型 15-90	320	65(148)	130(185)	158(175)	90(165)	12	17.5	60(48)	13(12)	146	168(/)	97.5(3)	114	22	40	35	7	25	11.5
750W 1HP	/	/	/	/	/	/	/	/	/	/	/	/	/	/	/	/	/	/	/	/
	缩框型 3-25	337	65(148)	130(185)	158(175)	90(165)	12	17.5	60(48)	13(12)	172	168(/)	97.5(3)	126	22	40	35	7	25	13.5

※表中“( )”内为立式箱体尺寸。  
※Labulation“( )”denote vertical box dimension.

输出轴容许扭矩 Output Torque

单位 Unit:kg.m

功率 Power	类型 Type	速 频 比 率	速 频 比 率																				
			3	5	10	15	20	25	30	40	45	50	60	70	80	90	100	120	140	160	180	200	
100W 1/8HP	标准型 Standard type	50Hz	/	/	/	/	/	/	/	/	/	/	3.40	3.90	4.50	5.10	5.60	6.80	7.90	9.00	10.1	11.3	
		60Hz	/	/	/	/	/	/	/	/	/	/	2.80	3.30	3.70	4.20	4.60	5.60	6.50	7.40	8.40	9.30	
	缩框型 Light duty type	50Hz	/	/	/	/	/	/	/	/	/	/	/	/	/	/	/	/	/	/	/	/	/
		60Hz	/	/	/	/	/	/	/	/	/	/	/	/	/	/	/	/	/	/	/	/	/
200W 1/4HP	标准型 Standard type	50Hz	/	/	/	1.50	2.00	2.50	3.00	4.10	4.60	5.10	6.10	7.10	8.10	9.10	/	/	/	/	/	/	/
		60Hz	/	/	/	1.30	1.70	2.10	2.50	3.30	3.80	4.20	5.0	5.90	6.70	7.50	/	/	/	/	/	/	/
	缩框型 Light duty type	50Hz	/	/	/	/	/	/	/	/	/	/	/	/	/	/	10.1	11.6	11.6	11.6	11.6	11.6	11.6
		60Hz	/	/	/	/	/	/	/	/	/	/	/	/	/	/	8.40	10.0	11.6	11.6	11.6	11.6	11.6
400W 1/2HP	标准型 Standard type	50Hz	0.70	1.10	2.30	/	/	/	/	/	/	/	/	/	/	/	/	/	/	/	/	/	/
		60Hz	0.60	0.90	1.90	/	/	/	/	/	/	/	/	/	/	/	/	/	/	/	/	/	/
	缩框型 Light duty type	50Hz	/	/	/	3.00	4.10	5.10	6.10	8.10	9.10	10.1	10.3	10.3	10.3	/	/	/	/	/	/	/	/
		60Hz	/	/	/	2.50	3.30	4.20	5.00	6.70	7.50	8.40	10.3	10.3	10.3	/	/	/	/	/	/	/	/
750W 1HP	标准型 Standard type	50Hz	/	/	/	/	/	/	/	/	/	/	/	/	/	/	/	/	/	/	/	/	/
		60Hz	/	/	/	/	/	/	/	/	/	/	/	/	/	/	/	/	/	/	/	/	/
	缩框型 Light duty type	50Hz	1.30	2.10	4.20	5.70	7.60	9.50	/	/	/	/	/	/	/	/	/	/	/	/	/	/	/
		60Hz	1.00	1.70	3.50	4.70	6.30	7.80	/	/	/	/	/	/	/	/	/	/	/	/	/	/	/

高速比输出轴容许扭矩 (1# + 2#) High Ratio Output Shaft Torque (1# + 2#)

单位 Unit:kg.m

功率 Power	类型 Type	速 频 比 率	速 频 比 率																			
			250	300	350	400	450	500	600	700	800	900	1000	1100	1200	1300	1400	1500	1600	1700	1800	
100W 1/8HP	缩框型 Light duty type	50Hz	11.6	11.6	11.6	11.6	11.6	11.6	11.6	11.6	11.6	11.6	11.6	11.6	11.6	11.6	11.6	11.6	11.6	11.6	11.6	11.6
		60Hz	11.6	11.6	11.6	11.6	11.6	11.6	11.6	11.6	11.6	11.6	11.6	11.6	11.6	11.6	11.6	11.6	11.6	11.6	11.6	11.6

# 3#齿轮箱出轴直径 $\Phi 28\text{mm}$ 配三相电机技术参数

## 3# GEARBOX WITH SHAFT DIA $\Phi 28\text{mm}$ WITH 3-PHASE MOTOR PARAMETERS

■ 卧式 Horizontal      ■ 立式 Vertical



■ 卧式 Horizontal

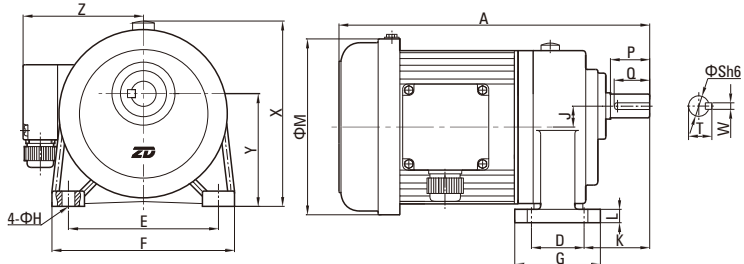

■ 立式 Vertical

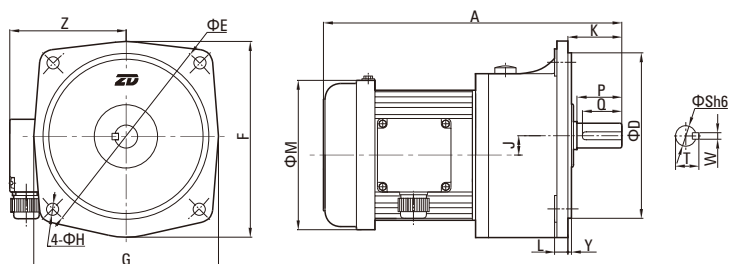

■ 高速比(1#+3#) High Ratio(1#+3#)



■ 卧式 Horizontal

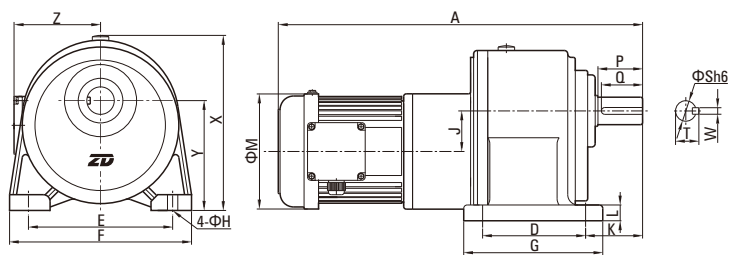

■ 立式 Vertical

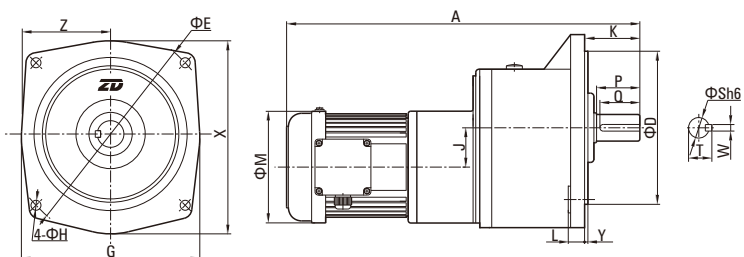



# 4#齿轮箱出轴直径 $\Phi 32\text{mm}$ 配三相电机技术参数

## 4# GEARBOX WITH SHAFT DIA $\Phi 32\text{mm}$ WITH 3-PHASE MOTOR PARAMETERS

■ 卧式 Horizontal      ■ 立式 Vertical



■ 卧式 Horizontal

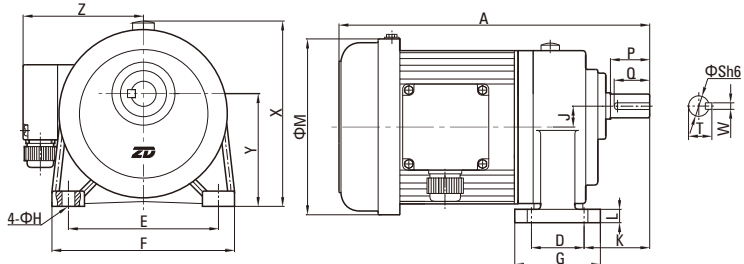

■ 立式 Vertical

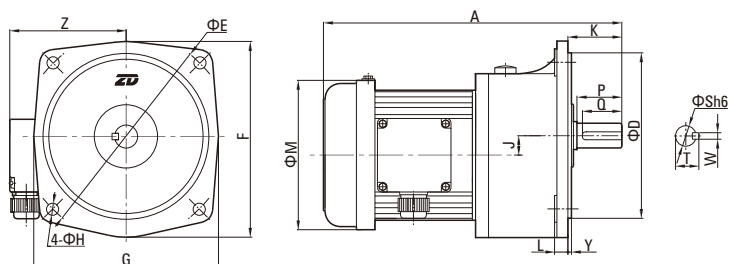

■ 高速比(2# + 4#) High Ratio(2# + 4#)



■ 卧式 Horizontal

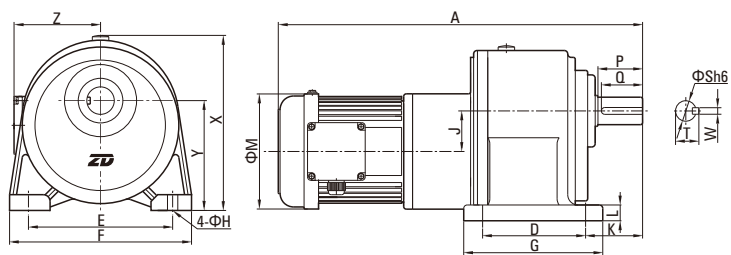

■ 立式 Vertical

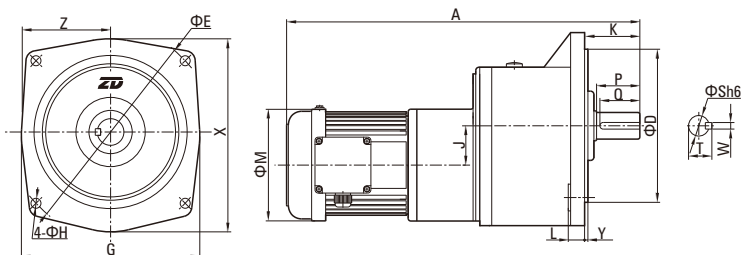





# 5#齿轮箱出轴直径 $\Phi 40\text{mm}$ 配三相电机技术参数

## 5# GEARBOX WITH SHAFT DIA $\Phi 40\text{mm}$ WITH 3-PHASE MOTOR PARAMETERS

■ 卧式 Horizontal      ■ 立式 Vertical



■ 卧式 Horizontal

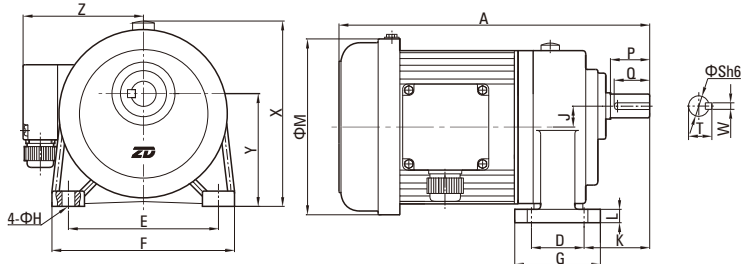

■ 立式 Vertical

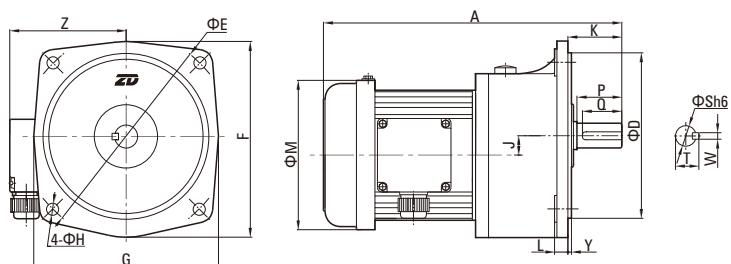

■ 高速比(3#+5#) High Ratio(3#+5#)



■ 卧式 Horizontal

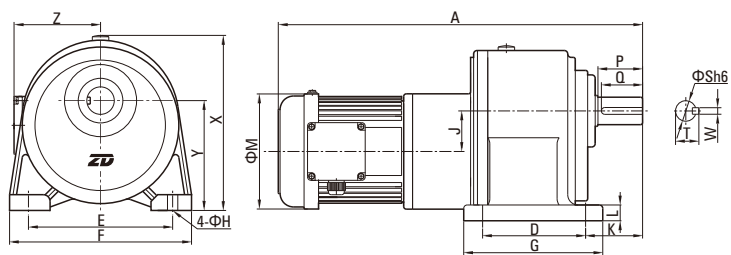

■ 立式 Vertical

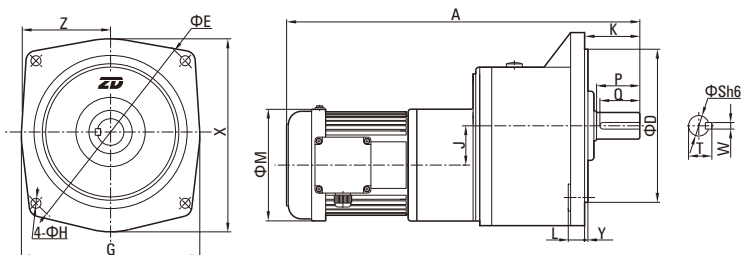



# 6#齿轮箱出轴直径Φ50mm配三相电机技术参数 6# GEARBOX WITH SHAFT DIA Φ50mm WITH 3-PHASE MOTOR PARAMETERS

■ 卧式 Horizontal      ■ 立式 Vertical



■ 卧式 Horizontal

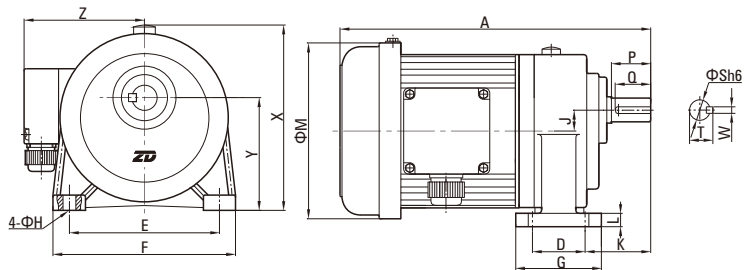

■ 立式 Vertical

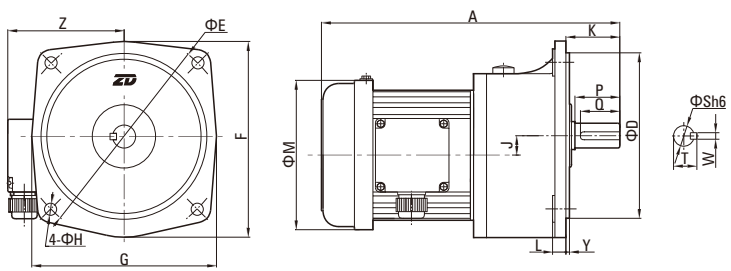

## 尺寸表 Size Table

单位 Unit:mm

功率 Power	减速比 Ratio	A	D	E	F	G	H	J	K	L	M	X	Y	Z	S	P	Q	W	T	重量 Weight
1500W 2HP	标准型 110-180	555	170(280)	265(390)	335(367)	238(342)	18	51	97(92)	25	192	312(/)	200(5)	137	50	80	75	14	54	94.0
2200W 3HP	标准型 45-100	575	170(280)	265(390)	335(367)	238(342)	18	51	97(92)	25	192	312(/)	200(5)	137	50	80	75	14	54	97.0
3700W 5HP	标准型 15-60	605	170(280)	265(390)	335(367)	238(342)	18	51	97(92)	25	213	312(/)	200(5)	160	50	80	75	14	54	98.0

※表中“( )”内为立式箱体尺寸。  
※Labulation“( )”denote vertical box dimension.

## 输出轴容许扭矩 Output Torque

单位 Unit:kg.m

功率 Power	类型 Type	速比 频率	3	5	10	15	20	25	30	40	45	50	60	70	80	90	100	120	140	*160	*180	*200
1500W 2HP	标准型 Standard type	50Hz	/	/	/	/	/	/	/	/	/	/	/	/	/	/	/	91.30	106.6	121.8	137.0	/
		60Hz	/	/	/	/	/	/	/	/	/	/	/	/	/	/	/	/	75.20	87.80	100.3	112.8
2200W 3HP	标准型 Standard type	50Hz	/	/	/	/	/	/	/	50.20	55.80	67.00	78.10	89.30	100.5	111.6	/	/	/	/	/	/
		60Hz	/	/	/	/	/	/	/	41.40	46.00	55.20	64.40	73.50	82.70	91.90	/	/	/	/	/	/
3700W 5HP	标准型 Standard type	50Hz	/	/	/	31.30	41.70	52.20	56.30	75.10	84.50	93.90	112.6	/	/	/	/	/	/	/	/	/
		60Hz	/	/	/	25.80	34.40	42.90	46.40	61.80	69.60	77.30	92.80	/	/	/	/	/	/	/	/	/

※备注：\*为达到此速此时，必须搭配6P马达使用。  
※Note: In order to reach this ratio, must be used 6P motor.

# 1#齿轮箱出轴直径Φ18mm配单相电机技术参数 1#GEARBOX WITH SHAFT DIA Φ18mm WITH 1-PHASE MOTOR PARAMETERS

## 卧式 Horizontal

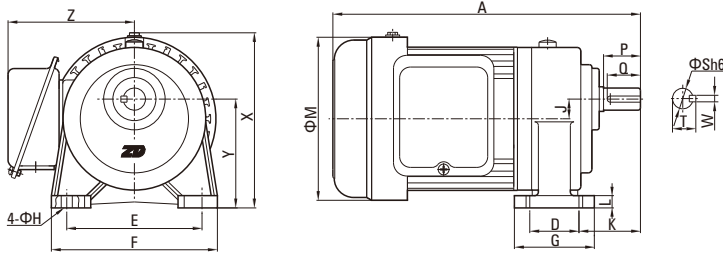

## 立式 Vertical

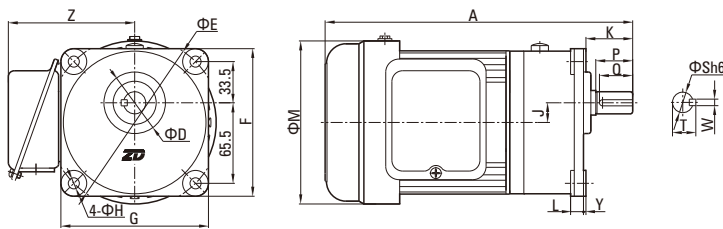

## 尺寸表 Size Table

单位 Unit:mm

功率 Power	减速比 Ratio	A	D	E	F	G	H	J	K	L	M	X	Y	Z	S	P	Q	W	T	重量 Weight
100W 1/8HP	标准型 3-50	250	40(50)	110(140)	135(120)	65(120)	9	16	50(40)	10.5(12)	133	138(/)	88.5(2)	105	18	30	27	5	20.2	5.7
	缩框型 60-200	250	40(50)	110(140)	135(120)	65(120)	9	16	50(40)	10.5(12)	133	138(/)	88.5(2)	105	18	30	27	5	20.2	5.7
200W 1/4HP	标准型 3-10	285	40(50)	110(140)	135(120)	65(120)	9	16	50(40)	10.5(12)	133	138(/)	88.5(2)	105	18	30	27	5	20.2	7.0
	缩框型 15-90	285	40(50)	110(140)	135(120)	65(120)	9	16	50(40)	10.5(12)	133	138(/)	88.5(2)	105	18	30	27	5	20.2	7.0

※表中“( )”内为立式箱体尺寸。

※Labulation“( )”denote vertical box dimension.

## 输出轴容许扭矩 Output Torque

单位 Unit:kg.m

功率 Power	类型 Type	速 频 率	速 率																				
			3	5	10	15	20	25	30	40	45	50	60	70	80	90	100	120	140	160	180	200	
100W 1/8HP	标准型 Standard type	50Hz	0.20	0.30	0.60	0.80	1.10	1.40	1.70	2.30	2.50	2.80	/	/	/	/	/	/	/	/	/	/	/
		60Hz	0.16	0.26	0.52	0.76	1.00	1.20	1.50	1.90	2.20	2.30	/	/	/	/	/	/	/	/	/	/	/
	缩框型 Light duty type	50Hz	/	/	/	/	/	/	/	/	/	/	3.40	3.40	3.40	3.40	3.40	3.40	3.40	3.40	3.40	3.40	3.40
		60Hz	/	/	/	/	/	/	/	/	/	/	3.40	3.40	3.40	3.40	3.40	3.40	3.40	3.40	3.40	3.40	3.40
200W 1/4HP	标准型 Standard type	50Hz	0.30	0.60	1.10	/	/	/	/	/	/	/	/	/	/	/	/	/	/	/	/	/	/
		60Hz	0.30	0.50	0.90	/	/	/	/	/	/	/	/	/	/	/	/	/	/	/	/	/	/
	缩框型 Light duty type	50Hz	/	/	/	1.70	2.30	2.80	3.40	3.40	3.40	3.40	3.40	3.40	3.40	3.40	/	/	/	/	/	/	/
		60Hz	/	/	/	1.40	1.90	2.30	3.40	3.40	3.40	3.40	3.40	3.40	3.40	3.40	/	/	/	/	/	/	/

2#齿轮箱出轴直径  $\Phi 22\text{mm}$  配单相电机技术参数  
 2# GEARBOX WITH SHAFT DIA  $\Phi 22\text{mm}$  WITH 1-PHASE MOTOR PARAMETERS

■ 卧式 Horizontal      ■ 立式 Vertical



■ 卧式 Horizontal

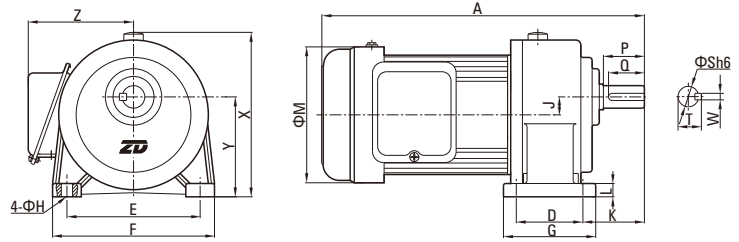

■ 立式 Vertical

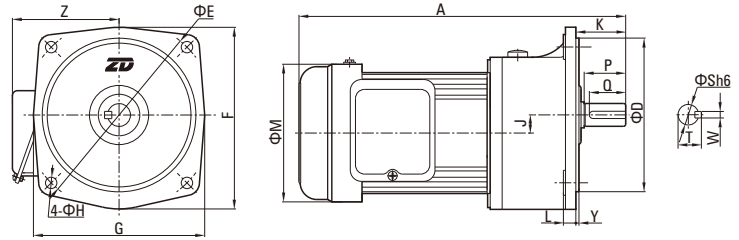

■ 高速比(1#+2#) High Ratio(1#+2#)



■ 卧式 Horizontal

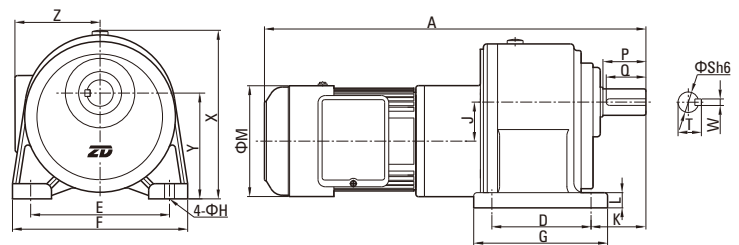

■ 立式 Vertical

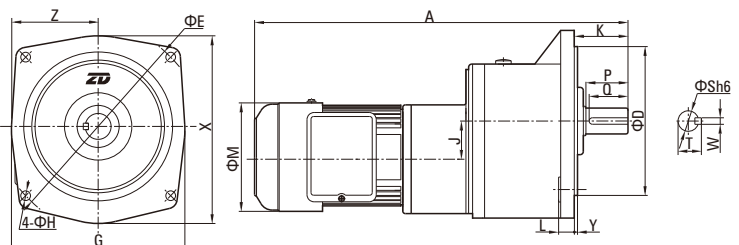

## 2#齿轮箱出轴直径Φ22mm配单相电机技术参数 2#GEARBOX WITH SHAFT DIA Φ22mm WITH 1-PHASE MOTOR PARAMETERS

尺寸表 Size Table

单位 Unit:mm

功率 Power	减速比Ratio	A	D	E	F	G	H	J	K	L	M	X	Y	Z	S	P	Q	W	T	重量Weight
100W 1/8HP	标准型60-200	280	65(148)	130(185)	158(175)	90(165)	12	17.5	60(48)	13(12)	133	152(/)	97.5(3)	105	22	40	35	7	25	7.30
	缩框型250-180 (1#+2#)	345	65(148)	130(185)	158(175)	90(165)	12	33.5	60(48)	13(12)	133	152(/)	97.5(3)	105	22	40	35	7	25	12.0
200W 1/4HP	标准型15-90	315	65(148)	130(185)	158(175)	90(165)	12	17.5	60(48)	13(12)	133	152(/)	97.5(3)	105	22	40	35	7	25	9.00
	缩框型100-200	315	65(148)	130(185)	158(175)	90(165)	12	17.5	60(48)	13(12)	133	152(/)	97.5(3)	105	22	40	35	7	25	9.00
400W 1/2HP	标准型3-10	360	65(148)	130(185)	158(175)	90(165)	12	17.5	60(48)	13(12)	167	152(/)	97.5(3)	135	22	40	35	7	25	11.5
	缩框型15-90	360	65(148)	130(185)	158(175)	90(165)	12	17.5	60(48)	13(12)	167	152(/)	97.5(3)	135	22	40	35	7	25	11.5
750W 1HP	/	/	/	/	/	/	/	/	/	/	/	/	/	/	/	/	/	/	/	/
	缩框型3-25	380	65(148)	130(185)	158(175)	90(165)	12	17.5	60(48)	13(12)	167	152(/)	97.5(3)	135	22	40	35	7	25	13.5

※表中“( )”内为立式箱体尺寸。

※Labulation“( )”denote vertical box dimension.

输出轴容许扭矩 Output Torque

单位 Unit:kg.m

功率 Power	类型 Type	速 频 率	3	5	10	15	20	25	30	40	45	50	60	70	80	90	100	120	140	160	180	200	
100W 1/8HP	标准型 Standard type	50Hz	/	/	/	/	/	/	/	/	/	/	3.40	3.90	4.50	5.10	5.60	6.80	7.90	9.00	10.1	11.3	
		60Hz	/	/	/	/	/	/	/	/	/	/	2.80	3.30	3.70	4.20	4.60	5.60	6.50	7.40	8.40	9.30	
	缩框型 Light duty type	50Hz	/	/	/	/	/	/	/	/	/	/	/	/	/	/	/	/	/	/	/	/	/
		60Hz	/	/	/	/	/	/	/	/	/	/	/	/	/	/	/	/	/	/	/	/	/
200W 1/4HP	标准型 Standard type	50Hz	/	/	/	1.50	2.00	2.50	3.00	4.10	4.60	5.10	6.10	7.10	8.10	9.10	/	/	/	/	/	/	
		60Hz	/	/	/	1.30	1.70	2.10	2.50	3.30	3.80	4.20	5.00	5.90	6.70	7.50	/	/	/	/	/	/	
	缩框型 Light duty type	50Hz	/	/	/	/	/	/	/	/	/	/	/	/	/	/	10.1	11.6	11.6	11.6	11.6	11.6	
		60Hz	/	/	/	/	/	/	/	/	/	/	/	/	/	/	8.40	10.0	11.6	11.6	11.6	11.6	
400W 1/2HP	标准型 Standard type	50Hz	0.70	1.10	2.30	/	/	/	/	/	/	/	/	/	/	/	/	/	/	/	/	/	
		60Hz	0.60	0.90	1.90	/	/	/	/	/	/	/	/	/	/	/	/	/	/	/	/	/	
	缩框型 Light duty type	50Hz	/	/	/	3.00	4.10	5.10	6.10	8.10	9.10	10.1	10.3	10.3	10.3	/	/	/	/	/	/	/	
		60Hz	/	/	/	2.50	3.30	4.20	5.00	6.70	7.50	8.40	10.3	10.3	10.3	/	/	/	/	/	/	/	
750W 1HP	标准型 Standard type	50Hz	/	/	/	/	/	/	/	/	/	/	/	/	/	/	/	/	/	/	/	/	
		60Hz	/	/	/	/	/	/	/	/	/	/	/	/	/	/	/	/	/	/	/	/	
	缩框型 Light duty type	50Hz	1.30	2.10	4.20	5.70	7.60	9.50	/	/	/	/	/	/	/	/	/	/	/	/	/	/	
		60Hz	1.00	1.70	3.50	4.70	6.30	7.80	/	/	/	/	/	/	/	/	/	/	/	/	/	/	

高速比输出轴容许扭矩 (1#+2#) High Ratio Output Shaft Torque (1#+2#)

单位 Unit:kg.m

功率 Power	类型 Type	速 频 率	250	300	350	400	450	500	600	700	800	900	1000	1100	1200	1300	1400	1500	1600	1700	1800	
100W 1/8HP	缩框型 Light duty type	50Hz	11.6	11.6	11.6	11.6	11.6	11.6	11.6	11.6	11.6	11.6	11.6	11.6	11.6	11.6	11.6	11.6	11.6	11.6	11.6	11.6
		60Hz	11.6	11.6	11.6	11.6	11.6	11.6	11.6	11.6	11.6	11.6	11.6	11.6	11.6	11.6	11.6	11.6	11.6	11.6	11.6	11.6

### 3#齿轮箱出轴直径 $\Phi 28\text{mm}$ 配单相电机技术参数 3# GEARBOX WITH SHAFT DIA $\Phi 28\text{mm}$ WITH 1-PHASE MOTOR PARAMETERS

■ 卧式 Horizontal      ■ 立式 Vertical



■ 卧式 Horizontal

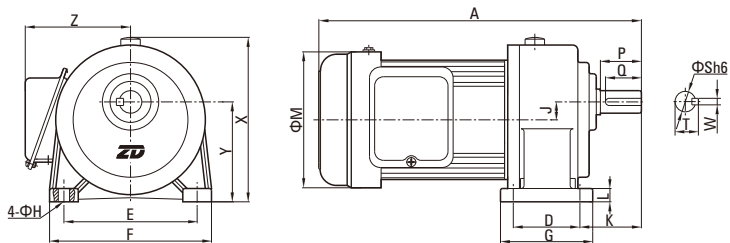

■ 立式 Vertical

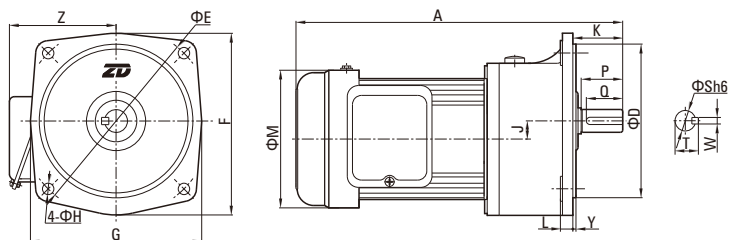

■ 高速比(1#+3#) High Ratio(1#+3#)



■ 卧式 Horizontal

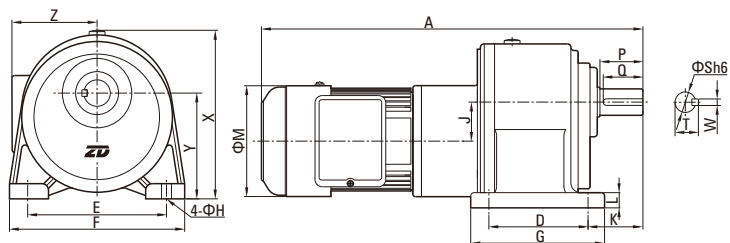

■ 立式 Vertical

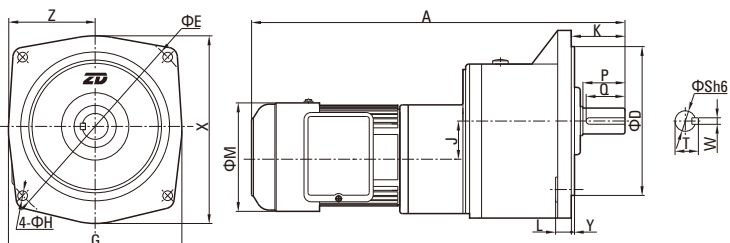





# 4#齿轮箱出轴直径 $\Phi 32\text{mm}$ 配单相电机技术参数

## 4# GEARBOX WITH SHAFT DIA $\Phi 32\text{mm}$ WITH 1-PHASE MOTOR PARAMETERS

■ 卧式 Horizontal      ■ 立式 Vertical



■ 卧式 Horizontal

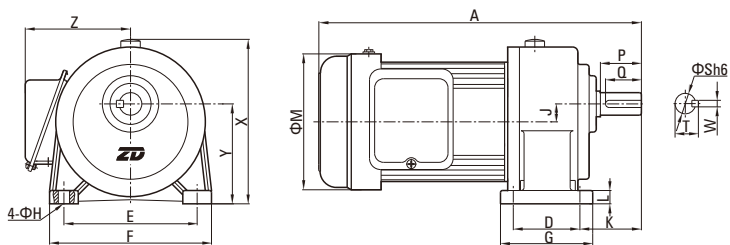

■ 立式 Vertical

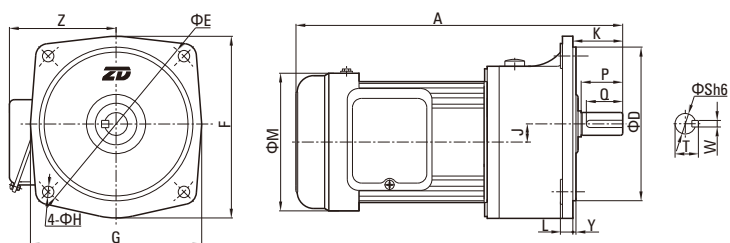

■ 高速比(2#+4#) High Ratio(2#+4#)



■ 卧式 Horizontal

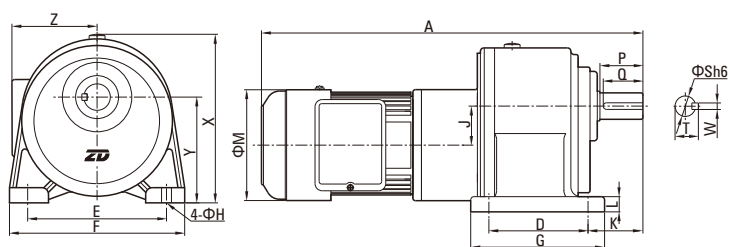

■ 立式 Vertical

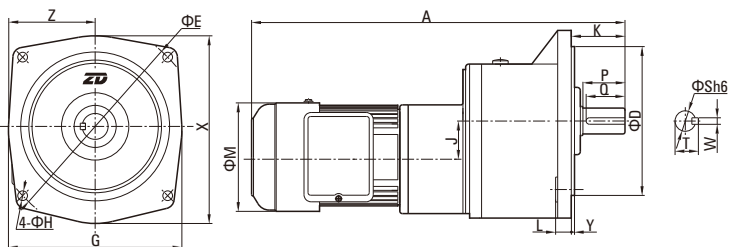



# 5#齿轮箱出轴直径 $\Phi 40\text{mm}$ 配单相电机技术参数

## 5# GEARBOX WITH SHAFT DIA $\Phi 40\text{mm}$ WITH 1-PHASE MOTOR PARAMETERS

■ 卧式 Horizontal      ■ 立式 Vertical



■ 卧式 Horizontal

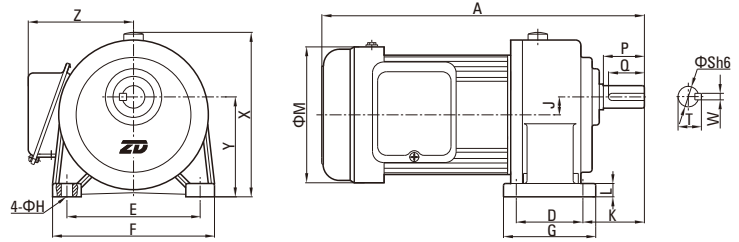

■ 立式 Vertical

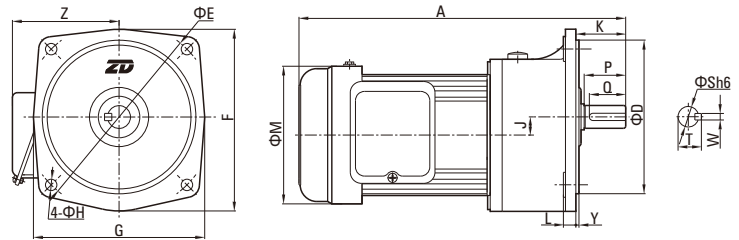

■ 高速比(3#+5#) High Ratio(3#+5#)



■ 卧式 Horizontal

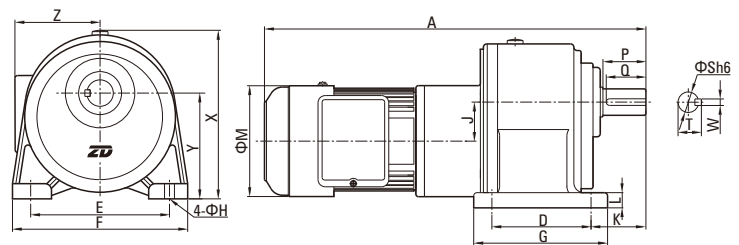

■ 立式 Vertical

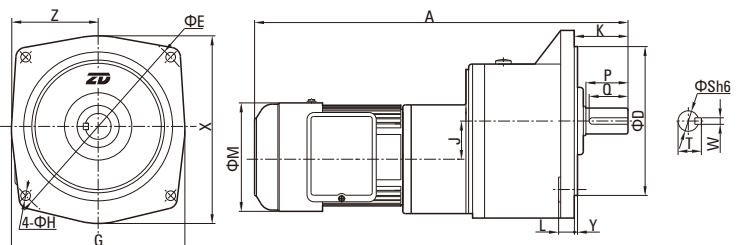

# 5#齿轮箱出轴直径Φ40mm配单相电机技术参数 5#GEARBOX WITH SHAFT DIA Φ40mm WITH 1-PHASE MOTOR PARAMETERS

尺寸表 Size Table

单位 Unit:mm

功率 Power	减速比 Ratio	A	D	E	F	G	H	J	K	L	M	X	Y	Z	S	P	Q	W	T	重量 Weight
400W 1/2HP	标准型250-1800 (3#+5#)	580	150(230)	210(310)	265(277)	203(255)	15	59	83	20(18)	167	255(/)	160(5)	135	40	65	60	10	43.5	46.0
	缩框型	/	/	/	/	/	/	/	/	/	/	/	/	/	/	/	/	/	/	/
750W 1HP	标准型125-200	500	150(230)	210(310)	265(277)	203(255)	15	36	83	20(18)	167	255(/)	160(5)	135	40	65	60	10	43.5	42.5
	缩框型250-1800 (3#+5#)	600	150(230)	210(310)	265(277)	203(255)	15	59	83	20(18)	167	255(/)	160(5)	200	40	65	60	10	43.5	50.0
1500W 2HP	标准型40-100	503	150(230)	210(310)	265(277)	203(255)	15	36	83	20(18)	192	255(/)	160(5)	139	40	65	60	10	43.5	52.0
	缩框型110-150	503	150(230)	210(310)	265(277)	203(255)	15	36	83	20(18)	192	255(/)	160(5)	139	40	65	60	10	43.5	52.0

※表中“( )”内为立式箱体尺寸。

※Labulation“( )”denote vertical box dimension.

输出轴容许扭矩 Output Torque

单位 Unit:kg.m

功率 Power	类型 Type	速 频 比 率																				
			3	5	10	15	20	25	30	40	45	50	60	70	80	90	100	120	140	160	180	200
750W 1HP	标准型 Standard type	50Hz	/	/	/	/	/	/	/	/	/	/	/	/	/	/	/	/	48.0	54.8	61.7	68.5
		60Hz	/	/	/	/	/	/	/	/	/	/	/	/	/	/	/	/	43.9	50.1	56.4	62.7
	缩框型 Light duty type	50Hz	/	/	/	/	/	/	/	/	/	/	/	/	/	/	/	/	/	/	/	/
		60Hz	/	/	/	/	/	/	/	/	/	/	/	/	/	/	/	/	/	/	/	/
1500W 2HP	标准型 Standard type	50Hz	/	/	/	/	/	/	/	30.4	34.3	38.1	45.7	53.3	60.9	68.5	76.1	/	/	/	/	
		60Hz	/	/	/	/	/	/	/	25.1	28.2	31.3	37.6	43.9	50.1	56.4	62.7	/	/	/	/	
	缩框型 Light duty type	50Hz	/	/	/	/	/	/	/	/	/	/	/	/	/	/	/	82.8	82.8	/	/	/
		60Hz	/	/	/	/	/	/	/	/	/	/	/	/	/	/	/	67.7	79.0	/	/	/

高速比输出轴容许扭矩 (3#+5#) High Ratio Output Shaft Torque (3#+5#)

单位 Unit:kg.m

功率 Power	类型 Type	速 频 比 率																			
			250	300	350	400	450	500	600	700	800	900	1000	1100	1200	1300	1400	1500	1600	1700	1800
400W 1/2HP	标准型 Standard type	50Hz	52.0	52.0	52.0	52.0	52.0	52.0	52.0	52.0	52.0	52.0	83.7	83.7	83.7	83.7	83.7	83.7	83.7	83.7	83.7
		60Hz	52.0	52.0	52.0	52.0	52.0	52.0	52.0	52.0	52.0	52.0	83.7	83.7	83.7	83.7	83.7	83.7	83.7	83.7	83.7
750W 1HP	缩框型 Light duty type	50Hz	52.0	52.0	52.0	52.0	52.0	52.0	52.0	52.0	52.0	83.7	83.7	83.7	83.7	83.7	83.7	83.7	83.7	83.7	83.7
		60Hz	52.0	52.0	52.0	52.0	52.0	52.0	52.0	52.0	52.0	83.7	83.7	83.7	83.7	83.7	83.7	83.7	83.7	83.7	83.7

# 6#齿轮箱出轴直径Φ50mm配单相电机技术参数

## 6# GEARBOX WITH SHAFT DIA Φ50mm WITH 1-PHASE MOTOR PARAMETERS

■ 卧式 Horizontal      ■ 立式 Vertical



■ 卧式 Horizontal

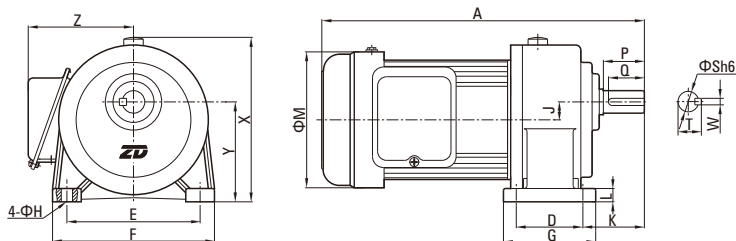

■ 立式 Vertical

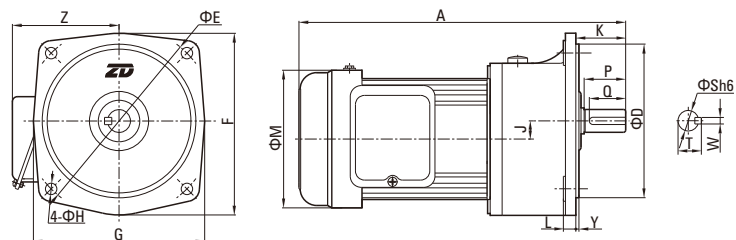

### 尺寸表 Size Table

单位 Unit:mm

功率 Power	减速比 Ratio	A	D	E	F	G	H	J	K	L	M	X	Y	Z	S	P	Q	W	T	重量 Weight
1500W 2HP	标准型 110-180	560	170(280)	265(390)	335(367)	230(342)	18	51	97(92)	25	192	312(/)	200(5)	146	50	80	75	14	54	94.0

※表中“( )”内为立式电机尺寸。

※Labulation“( )”denote vertical motor dimension.

### 输出轴容许扭矩 Output Torque

单位 Unit:kg.m

功率 Power	类型 Type	速比 频率	3	5	10	15	20	25	30	40	45	50	60	70	80	90	100	120	140	160	180	200
			1500W 2HP	标准型 Standard type	50Hz	/	/	/	/	/	/	/	/	/	/	/	/	/	/	/	91.30	106.6
		60Hz	/	/	/	/	/	/	/	/	/	/	/	/	/	/	/	75.20	87.80	/	/	/



# 输入法兰齿轮减速机技术参数 FLANGE TYPE REDUCER WITHOR MOTOR PARAMETERS

■ 卧式 Horizontal      ■ 立式 Vertical



■ ZHM 卧式 ZHM Horizontal

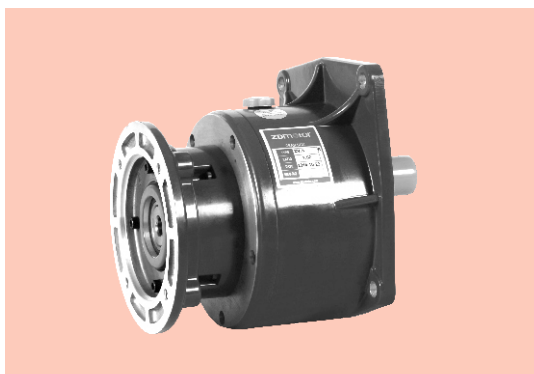
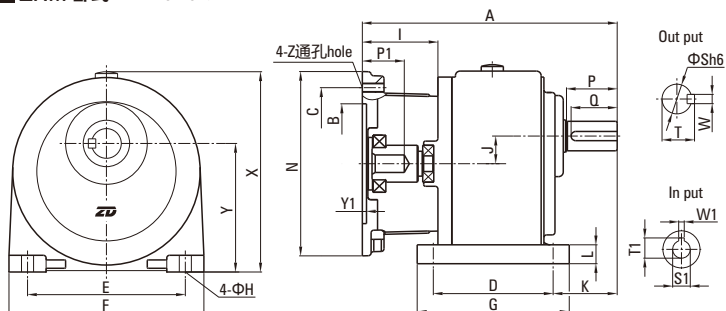

■ ZVM 立式 ZVM Vertical

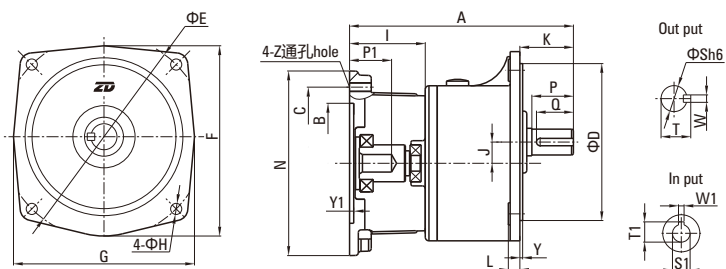

## 输入孔尺寸 Input Bore Size

功率 Power	输入孔 Input Bore		键槽 Keyway		
	S1	W1	T1	P1	
200W	Φ11	4	12.8	32.5	
400W	Φ14	5	16.3	32.5	
750W	Φ19	6	21.8	43.0	
1500W	Φ24	8	27.3	53.0	
2200W	Φ28	8	31.3	63.0	
3700W	Φ28	8	31.3	63.0	

## 输出轴尺寸 Output Shaft Size

型号 Size	输出轴 Output Shaft		键槽 Keyway			键 Key
	Sh6	P	W	T	Q	SPEC
1#	Φ18	30	5	20.2	27	5*5*27
2#	Φ22	40	7	25.0	35	7*7*35
3#	Φ28	45	7	31.3	40	7*7*40
4#	Φ32	55	10	35.5	50	10*8*50
5#	Φ40	65	10	43.5	60	10*8*60
6#	Φ50	80	14	54.0	75	14*9*75

# 输入法兰齿轮减速机技术参数

## FLANGE TYPE REDUCER WITHOR MOTOR PARAMETERS

### ■ 卧式输入法兰 Horizontal Type

单位 Unit:mm

功率 Power	减速比Ratio	型号	A	B	C	D	E	F	G	H	I	J	K	L	N	X	Y	Y1	Z
200W 1/4HP	3-10	1#	160	110	130	40	110	135	65	9	55	16.0	50	10.5	160	138	88.50	4.5	M8
	15-90	2#	195	110	130	65	130	158	90	12	55	17.5	60	13	160	152	97.50	4.5	M8
	100-200	3#	225	110	130	90	140	178	120	12	55	23.0	68	17	160	178	116.0	4.5	M8
400W 1/4HP	3-10	2#	195	110	130	65	130	158	90	12	55	17.5	60	13	160	152	97.50	4.5	M8
	15-90	3#	225	110	130	90	140	178	120	12	55	23.0	68	17	160	178	116.0	4.5	M8
	100-200	4#	255	110	130	130	170	210	165	13	55	30.0	70	18	160	216	138.5	4.5	M8
750W 1/4HP	3-25	3#	250	130	165	90	140	178	120	12	82	23.0	68	17	200	178	116.0	4.5	M10
	3-120	4#	285	130	165	130	170	210	165	13	82	30.0	70	18	200	216	138.5	4.5	M10
	125-200	5#	330	130	165	150	210	265	203	15	82	36.0	83	20	200	250	160.0	4.5	M10
1500W 2HP	3-30	4#	285	130	165	130	170	210	165	13	82	30.0	70	18	200	216	138.5	4.5	M10
	40-100	5#	330	130	165	150	210	265	203	15	82	36.0	83	20	200	250	160.0	4.5	M10
2200W 3HP	3-40	5#	355	180	215	150	210	265	203	15	105	36.0	83	20	250	250	160.0	5.0	M12
	45-100	6#	410	180	215	170	265	335	238	18	105	51.0	97	25	250	308	200.0	5.0	M12
3700W 5HP	3-10	5#	355	180	215	150	210	265	203	15	105	36.0	83	20	250	250	160.0	5.0	M12
	15-60	6#	410	180	215	170	265	335	235	18	105	51.0	97	25	250	308	200.0	5.0	M12

### ■ 立式输入法兰 Vertical Type

单位 Unit:mm

功率 Power	减速比Ratio	型号	A	B	C	D	E	F	G	H	I	J	K	L	N	Y	Y1	Z
200W 1/4HP	3-10	*1#	160	110	130	50	140	120	120	9	55	16.0	40.0	12	160	6	4.5	M8
	15-90	2#	195	110	130	148	185	175	165	12	55	17.5	48.0	12	160	3	4.5	M8
	100-200	3#	225	110	130	170	220	205	195	12	55	23.0	58.0	13	160	3	4.5	M8
400W 1/4HP	3-10	2#	195	110	130	148	185	175	165	12	55	17.5	48.0	12	160	3	4.5	M8
	15-90	3#	225	110	130	170	220	205	195	12	55	23.0	58.0	13	160	3	4.5	M8
	100-200	4#	255	110	130	185	255	239	216	13	55	30.0	66.5	16	160	3	4.5	M8
750W 1/4HP	3-25	3#	250	130	165	170	220	205	195	12	82	23.0	58.0	13	200	3	4.5	M10
	3-120	4#	285	130	165	185	255	239	216	13	82	30.0	66.5	16	200	3	4.5	M10
	125-200	5#	330	130	165	230	310	278	255	15	82	36.0	83.0	18	200	5	4.5	M10
1500W 2HP	3-30	4#	285	130	165	185	255	239	216	13	82	30.0	66.5	16	200	3	4.5	M10
	40-100	5#	330	130	165	230	310	278	255	15	82	36.0	83.0	18	200	5	4.5	M10
2200W 3HP	3-40	5#	355	180	215	230	310	278	255	15	105	36.0	83.0	18	250	5	5.0	M12
	45-100	6#	410	180	215	280	390	369	342	18	105	51.0	92.0	25	250	5	5.0	M12
3700W 5HP	3-10	5#	355	180	215	230	310	278	255	15	105	36.0	83.0	18	250	5	5.0	M12
	15-60	6#	410	180	215	280	390	369	342	18	105	51.0	92.0	25	250	5	5.0	M12

※备注：1.配合IEC电机为主  
2.\*属于B型输出法

※Note: 1.Available for IEC motor.  
2.Belong to type output flange.



## 安全注意事项 SAFETY CAUTIONS

<p>总体 General</p>	<p>请不要在齿轮箱及电机铭牌或产品目录的规格以外使用，以免触电，受伤及损坏装置等。 Please don't use motor out of the range which is clarified in of nameplate of gear box and motor and the specification of product catalogue, avoiding getting an electric shock, hurting or damaging the device.</p> <p>请不要把手指或物品进入齿轮或电机开口部分，以免触电、受伤、发生火灾及损坏装置等。 Please do not put your fingers into the opening part of gear of motor, in order to prevent getting an electric shock, hurting catching a fire or damaging device etc.</p> <p>请不要使用带伤的齿轮箱或电机，以免有可能受伤，发生火灾等。 Please do not use the injured gear head or motor, in order to prevent hurting, catching a fire etc.</p> <p>请不要拆下铭牌。 Please do not put off the nameplate.</p> <p>若客户对产品私自进行改造的，不属于保修范围，本公司不承担任何责任。 If the products are reformed by the customers personally, it no belongs to the guarantee scope, and our company doesn't undertake any responsibility.</p>
<p>搬动/Moving</p>	<p>搬动时，若发生脱落或倾倒，是很危险的，请充分注意。 When you move it, if it shed off or tit to one side, it is very dangerous, please pay more attention.</p>
<p>安装 Assembly</p>	<p>请绝对不要在齿轮箱和电机周围放置可燃物，以免发生火灾。 Please never put the flammable thing near and motor, for fear of a fire.</p> <p>请不要在电机周围放置物品，影响电机通风、冷却，甚至因异常多热而烫伤或发生火灾。 Please do not put the things around motor, otherwise it can effect ventilation and cooling, even burning or catching a fire because of too hot.</p> <p>裸手请不要触碰齿轮及电机轴端部、齿轮部的键槽，以免受伤。 Please do not touch the gear, the motor shaft and the key slot of the gear with naked hand, or you may be hurt.</p> <p>在食品机械等可能发生漏油的装置中，请在安装部分另加一个能盛油的油杯，防止万一漏油对产品有不良的影响。 The device may creating the smoke, such as food machine, please add an oil cup assembly part, to prevent leaking oil which may have a bad effect on the products.</p>
<p>对主机机械的连接 Assemble to the main machine</p>	<p>在旋转部分，请设安全罩等，防止受伤。 Please set a safe cover above the revolving part, to prevent being hurt.</p> <p>在与对方机械连接前，请确认旋转方向。若旋转方向不正确，有可能受伤或破坏装置。 Before linking to the other machine, please confirm the revolving direction is not right, it may hurt the gear motor or destroy the device.</p>
<p>配线/Wiring</p>	<p>在测试绝缘电阻时，请不要接触端子，以免触电危险。 Please don't get in touch with terminal, when you measure insure insulated resistance, preventing danger of getting an electric shock.</p>
<p>运转 Operation</p>	<p>请按照接线图或使用说明书实施与电源的连接，以免触电或发生火灾。（无端子箱的，请确实加强连接部分的绝缘） Please link with the electric source according to wire diagram and usage manual, in order to prevent getting an electric shock or catching a fire. (no terminal box, please strengthen the insulation of the connection part surely)</p> <p>对电源电缆和电机引线，请不要过分弯曲、拉伸、夹紧，以免触电危险。 Referring to the electrical source cable and the motor wire, please do not bend, stretch, and clip tightly excessively, in order to prevent getting an electric shock.</p> <p>接地端子应牢固接地，以免触电危险。务必使用符合铭牌要求的电源，以免烧毁电机、发生火灾。 The terminal box connecting to the ground must be firm, in order to prevent getting an electric shock.</p> <p>Please adopt the electrical source according to the nameplate, to avoid burning the motor and catching a fire.</p>
<p>日常检查保养 The daily check and maintain</p>	<p>在运转中，绝对不要接近或接触旋转物体（轴等）。有卷入受伤时，请马上切断电源开关，及时处理。 When operating, do not get close to or touch the revolving parts (shaft). If something or somebody engulfs or hurts, Please turn off the electrical power switch right and handle at once.</p> <p>停电时，请务必切断电源开关，防止来电后伤人或破坏装置。 Please turn off the electrical source switch when electricity stops, in order to prevent hurting the person and damaging the device.</p> <p>请注意：带有热保护的电机，当电机温度异常时会自动切断电源，当电机温度下降到一定值时，电机会自动恢复工作。 (注：电机在没有烧坏的情况下，会自动复原) Please note, motor with the thermal protector, when temperature of the motor is unusual, it will turn off the electrical source automatically, when the temperature of the motor fall down to a fixed data, the motor can work automatically. (Note: when the motor is not burned-not, the motor can work automatically)</p> <p>在平常时，保持电机在正常的工作环境工作运转。（特殊型号除外） In daily, you should keep the motor operating in the normal work environment. (Except the special model)</p> <p>检查时，请绝对不要接触旋转物体（轴等）。有可能被卷入、受伤。 While checking, please do not get close to or touch the revolving parts (shaft). Something or somebody may engulf of hurt.</p>
<p>接受货物时检查 Receiving confirm</p>	<p>请确认现货是否和订货一样。选择错误的产品，有可能导致电机受损或破坏装置等。 Please confirm if it is the right one with the order when receiving. Choosing wrong probably leads to damage of motor of damage the device and etc.</p>

## 故障排除 TROUBLE SHOUTING

### ■ 刹车故障排除 Trouble Remove Of Brake

不良故障 Trouble	原因分析 Possible Analysis	解决方式 Solution Method
刹车器不动作 No action of brake	未供电源 No power supply	供应电源 Supply power
	来令片磨损 Brake disc worn out	换新来令片 Use new brake disc
	间隙过大 Large backlash	调整间隙 Adjust backlash
	电源压力不足 Low voltage	提供正确电压 Use correct voltage
	电源供应器损坏 Power supply damage	电源供应器换新 Use new power
	异物入侵 Dirty inside	清洁零件 Clean parts
	使用电压错误 Wrong voltage	使用正确电压 Correct voltage
	接线脱落 Connect wire lost	重新接线 Re-connect wire
	来令片卡死 Brake disc locked	清洁零件 Clean parts
	刹车圈烧坏 Brake coil burned-out	刹车线圈换新 Use new brake disc
刹车移动 Brake moving	来令片磨损 Brake disc worn out	换新来令片 Supply power
	间隙过大 Large backlash	调整间隙 Adjust backlash
	来令片沾染油渍 Surface oil	清洁来令片 Clean brake disc
	负载过大 Over loading	重新设计 Re-design brake unit
	刹车表面歪斜 Disc surface twist	更换零件 Use new parts
	下降衡量过大 Huge momentum	机构重新设计 System re-design
	选用机型错误 Select wrong type	选用正确机型 Re-select unit
环境温度过高 No power supply	检查环境温度 Adjust temperature	

### ■ 减速机器故障排除 Trouble Shouting For Gearmotor

	不良故障 Trouble	原因分析 Possible Analysis	解决方式 Solution Method
噪音 Noise	齿轮敲击声 Knocking	齿轮表面受伤 Hurt gear surface	更换受伤齿轮组 Replace gear set
	连续性杂音 Continually	轴承损坏 Bad bearing	更换损坏轴承 Replace bearing
	周期性杂音 Periodically	异物附着齿面 Particle inside	检测齿轮齿面 Check gear
	嘶嘶声 Neight	油量不足 Lack of lubricant	添加润滑油 Fill with lub-oil
	继续性杂音 Intermittently	润滑油不洁 Dirty lubricant	更换新润滑油 Replace lubricant
振动 Vibration	固定底座振动 Mounting base vibration	安装平面歪斜 Bad surface mounting	重新调整固定底座 Re-adjust mounting base
	出力轴振动 Output shaft vibration	轴承损坏 Bad bearing	更换损坏轴承 Replace bearing
	内部齿轮零件振动 Inside gear parts vibration	齿轮受损 Gear wounded	更换受损齿轮 Replace wounded gear
	箱体振动 Housing vibration	齿轮组安装不良 Bad gear assembly	重新调整齿轮组 Re-adjust gear set
漏油 Leakage	油封漏油 Oil seal leakage	油封硬化 Oil seal too harden	更换损坏油封 Replace wounded oil seal
	箱体漏油 Housing leakage	箱体有砂孔 Box had sand hole	更换砂孔箱体 Replace sand hole box
	结合面漏油 Connect surface leakage	O-型环损坏 O-ring broken	更换损坏O-型环 Replace wounded O-ring
过热 Over heating	油封 Bad oil seal	油封太紧 Oil seal too tight	更换太紧油封 Replace tighten oil seal
	箱体过热 Housing too heat	过负载 Over load runing	重新计算负载马力 Re-calculate loading
	缺润滑油 Less lubricant	油量不足 Lack of lubricant	加入润滑油 Fill with lubricant
	马达过热 Motor too heat	马达过载 Overload motor	更换新马达 Replace new motor

## 刹车零件分解图 BRAKE UNIT SECTION DIAGRAM

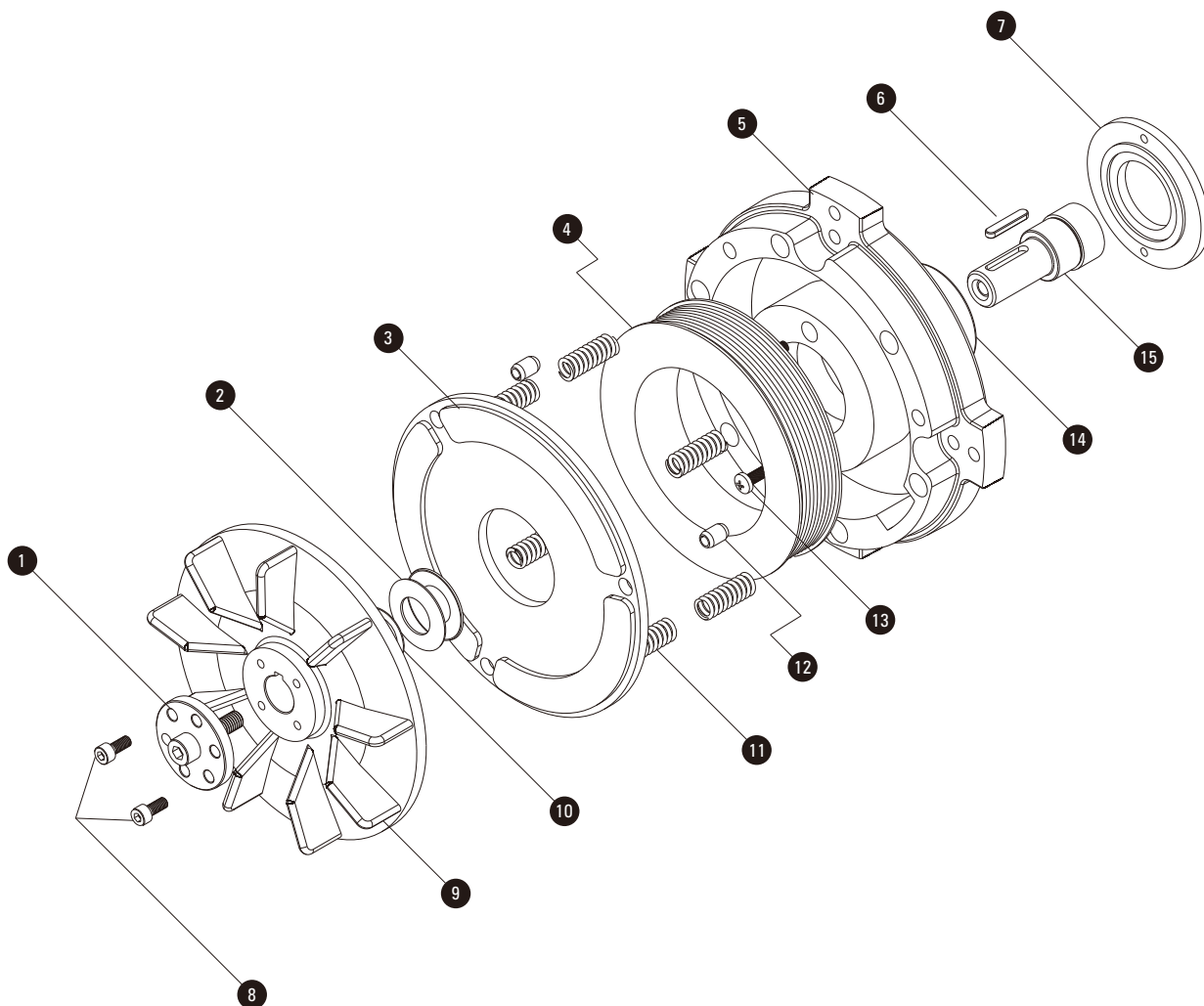

### 明细表 Parts List

序号 Item	名称 Name	序号 Item	名称 Name
1	调整螺栓 Gap adjustment bolt	9	散热风叶 Fan
2	蝶型弹簧 Disc spring	10	调整垫圈 Adjustment washer
3	摩擦来令片 Friction brake disc	11	压力弹簧 Pressure spring
4	激磁线圈 Brake coil	12	定位销 Fixed pin
5	刹车座 Brake housing	13	固定螺丝 M fixed screw
6	平键 Key	14	轴承 Bearing
7	轴承固定盖 Fixed bearing cover	15	马达轴 Motor
8	固定螺丝 Fixed screw		

## 连接系数表 CONNECTION FACTOR

### ■ 连结系数表 Connection Factor

配件名称 Parts Name	连结系数 Connection Factor
链轮 Sproket	1.00
齿轮 Gear	1.25
三角皮带 Belt	1.50
平皮带 Flat belt	2.50

### ■ 荷重系数表 Service Factor

减速负载等级 Load Grade	每日运转时间 (HRS) Daily Operating Hours			
	1-2	3-8	9-15	16-24
均一负载 Uniform load	0.80	0.90	1.20	1.30
中级冲击负载 Medium impact load	1.00	1.20	1.30	1.50
重级冲击负载 Heavy impact load	1.20	1.50	1.75	2.00

### ■ 基本传动公式 Basic Formular

名称 Name	公式 Basic Formular
减速比 (i)	$i = N/1800$
回转速度 (rpm)	$N = V/\pi D$
输出扭矩 (kg.m)	$T = W \times R \times K$
输入马力 (公制)	$kW1 = N \times T / 974$
输入马力 (英制)	$HP1 = N \times T / 716$
输入马力 (公制)	$kW2 = kW1 \times F / E$
输入马力 (英制)	$HP2 = HP1 \times F / E$

### ■ 符号说明 Code Details

符号 Code	说明 Details	符号 Code	说明 Details
V	速度 Speed (m/min)	E	效率 Efficiency (%)
I	减速比 Ratio	1 inch	= 2.54 cm
T	输出比例 (kg.m) Output torque	1 foot	= 12 inch
K	连结系数 Connecting factor	1 kW	= 1000 W
F	荷重系数 Service factor	1 kW	= 1.34 hp
W	荷重 (kg) Load	1 kg.m	= 7.233 ft-lb
N	出力轴转速 (rpm)	1 kg.m	= 86.8 in-lb
D	滚轮直径 (mm) Roller diameter	1 kg	= 2.2 lb
R	滚轮直径半径 (mm) Roller radius	1 lb	= 0.4536 kg
kW1(HP1)	输入功率 Input power	1 cm	= 10 mm
kW2(HP2)	输出功率 Output power	1 cm	= 0.3937 inch

## 标准实际速比 NORMAL RATIO & ACTUAL RATIO

### 标准型 Normal Duty Type

速比 Ratio	低段实际减速比 Actual Ratio						
	100W	200W	400W	750W	1500W	2200W	3700W
3	3.0800	3.0800	2.9600	2.9300	3.1400	2.990	2.990
5	4.8800	4.8800	5.0500	5.0300	5.2000	5.080	5.080
10	9.9900	9.9900	10.290	9.9700	10.180	10.09	10.09
15	14.950	14.740	15.010	15.020	15.350	15.35	14.69
20	19.900	20.370	20.680	19.860	20.730	20.17	19.83
25	24.440	25.250	25.450	24.700	25.800	25.30	25.09
30	30.800	32.090	30.120	30.180	30.100	29.6	31.50
40	40.330	40.190	39.330	40.240	39.620	38.15	39.24
50	50.600	51.060	50.210	50.300	51.360	49.19	49.26
60	61.830	62.190	59.430	60.290	59.730	59.88	60.67
70	72.290	72.180	69.590	69.740	69.330	70.70	
80	78.560	79.840	81.220	80.340	79.180	78.33	
90	92.670	91.040	92.500	90.170	88.530	87.35	
100	102.97	98.060	99.380	98.150	99.760	98.18	
110	112.87	109.43	111.95	110.00			
120	120.93	119.00	119.10	117.78	122.56		
130	132.79	132.21	129.63	132.81			
140	143.86	142.92	138.89	139.67	137.87		
150	149.39	146.63	149.51	151.93			
160	161.84	161.15	161.97	158.93	***165.02		
170	165.57	173.37	168.52	170.76			
180	182.75	176.03	183.63	179.82	***183.82		
200	201.02	193.37	201.99	198.89	***206.90		

※\*\*\*为达到此速比时，必须搭配6P马达使用 ※\*\*\*It need use 6 pole motor to reach certain ratio

速比 Ratio	高段实际减速比 Actual Ratio						
	100W	200W	400W	750W	1500W	2200W	3700W
300	300.010	317.750	311.610				
400	413.340	429.110	409.450				
450	453.720						
500	508.680	534.060	513.590				
600	602.020	624.730	600.880				
700	704.760		679.850				
800	786.110	832.970	774.450				
900	920.420	927.570	938.270				
1000	1003.57	1041.21	1042.61				
1100	1105.31						
1200	1187.86	1248.00	1212.52				
1300	1284.40						
1400	1390.93	1443.62	1407.40				
1500	1516.05						
1600	1623.38	1663.04	1607.35				
1700	1703.73						
1800	1848.84	1866.52	1797.16				

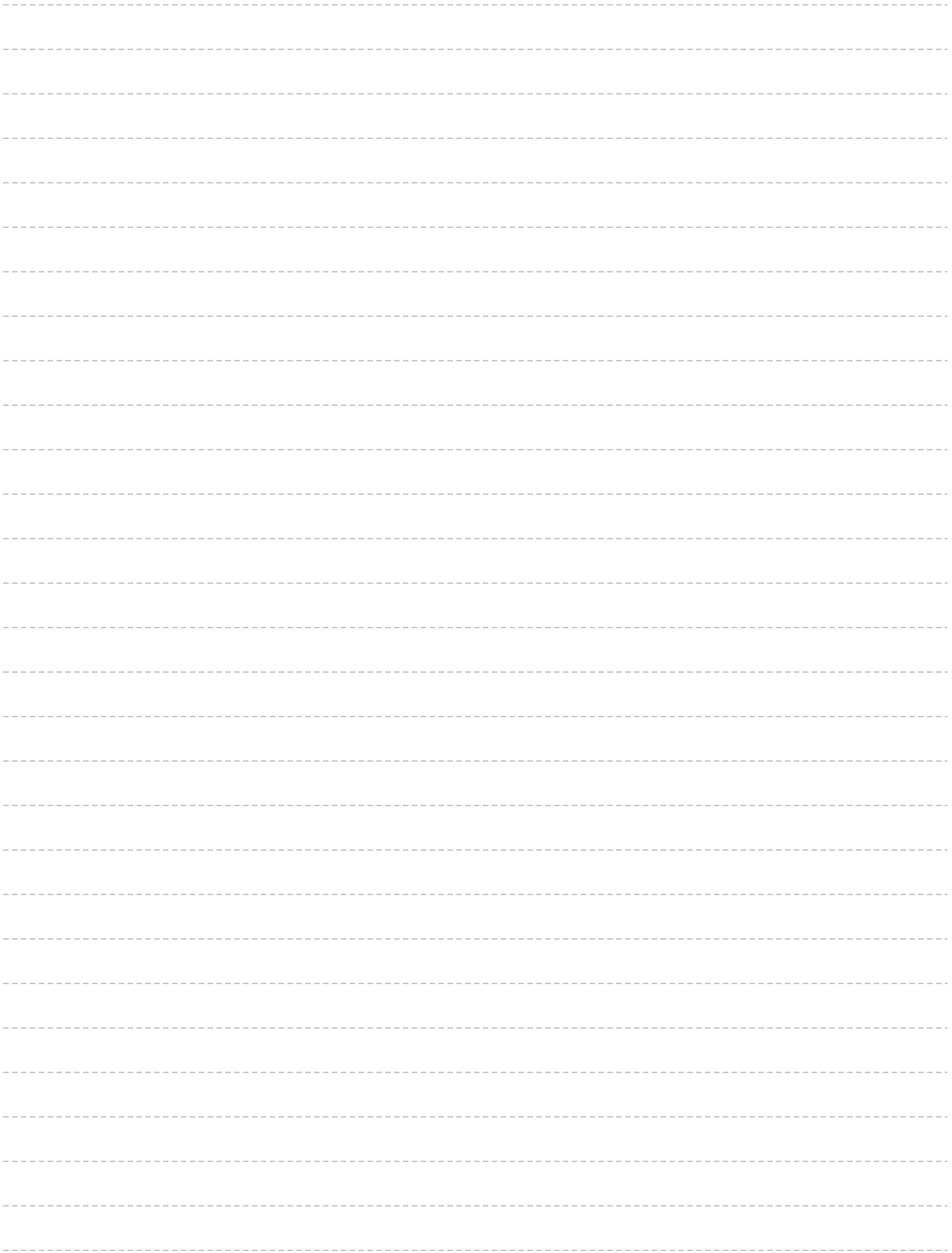

# CATALOGUE



精密谐波齿轮减速器  
PRECISION STRAIN WAVE GEAR REDUCER

ZD 中大刀德



摆线针轮精密减速器  
CYCLOIDAL PIN WHEEL PRECISION REDUCER

ZD 中大刀德



传动行星减速电机  
TRANSMISSION PLANETARY

ZD 中大刀德



ZB/ZBR/ZE/ZER/HD/HDR系列  
高精度行星减速机  
PLANETARY GEAR BOX

ZD 中大刀德



交、直流直角轴减速电动机  
AC & DC RIGHT ANGLE GEAR MOTOR

ZD 中大刀德



微型永磁无刷齿轮减速电机  
DC BRUSHLESS GEAR MOTOR

ZD 中大刀德

## SMALL AC GEAR MOTOR CATALOGUE

**宁波中大力德智能传动股份有限公司**  
**NINGBO ZHONGDA LEADER INTELLIGENT TRANSMISSION CO.,LTD.**  
地址：浙江省慈溪高新技术产业开发区新兴一路185号  
Add: NO.185 1st xinxing road, new industrial zone, cixi city, zhejiang, china.

**宁波中大创远精密传动设备有限公司**  
**ZHONGDA CHUANGYUAN PRECISE TRANSMISSION EQUIPMENT CO.,LTD.**  
地址：浙江省慈溪市杭州湾新区金慈路159号  
Add: No.159 jinci road, hangzhou bay district, cixi city, zhejiang, china.

**国内贸易服务：**  
电话：86-574-63537377  
传真：86-574-63534879  
E-mail: china@zd-motor.com

**国际贸易服务：**  
International trade department:  
Tel: 86-574-63537171 Fax: 86-574-63534879  
E-mail: sales@zd-motor.com  
Web: www.zddriver.com  
www.zd-motor.com

更多详情，敬请浏览：  
**www.zd-motor.com**